

COMMERCIAL GRADE
AUTOMOTIVE GRADE
HIGH RELIABILITY APPLICATIONS

2014 CAPACITOR

leaded disc radial lead

- C Series
- CEU Series
- CGJ Series
- CKG Series
- FK Series
- TSF Series
- UHV Series
- CD Series
- CGA Series
- CK Series
- CLL Series
- GA Series
- FD Series
- FHV Series
- CGB Series
- CKC Series
- CS Series
- H Series
- MD Series

multilayer ceramic chip capacitors

PRODUCT GUIDE

- General Capacitor Mid Voltage Capacitor
- High Voltage Capacitor MEGACAP Type
- Soft Termination High Temperature
- Open Mode Design 2in1 & 4in1 Array Type
- Reversed Geometry Ultra Low Inductance
- Conductive Epoxy Serial Design
- High Reliability Low Profile
- Radial Lead Type Leaded Disc Type
- Metal Fitting Type ESD Protection



TDK Corporation of America

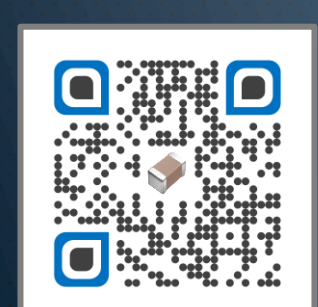

2	Message to Customers
3 - 4	Product Line Summary
5 - 6	Catalog Number Description
7 - 24	Series Summary
7	General Voltage
8	Mid Voltage
9	High Voltage
10	High Temperature
11	MEGACAP Type
12	Soft Termination
13	Open Mode
14	2in1 / 4in1 Array
15	Low Profile
16	Reversed Geometry
17	Ultra Low Inductance
18	Conductive Epoxy
19	Serial Design
20	ESD Protection
21	High Reliability
22	Radial Lead Type
23	Leaded Disc Type
24	Metal Fitting Type - Ultra High Voltage
25	E-Series Reference
26	Sales Contacts



Features

Characteristics

	GENERAL VOLTAGE CERAMIC CAPACITOR	 	<ul style="list-style-type: none"> ❖ TDK's proprietary internal electrode structure ❖ Wide capacitance range up to 100μF ❖ Available voltage rating of 4V to 50V ❖ Superior mechanical strength and reliability ❖ Low ESR characteristic ❖ Easy mounting due to no polarity 	<ul style="list-style-type: none"> ❖ Case Size: 01005 – 2220 ❖ Temperature Characteristics: CH, JB, C0G, X5R, X6S, X7R, X7S ❖ Voltage: 4V - 50V ❖ Cap Range: Up to 100μF
	MID VOLTAGE CERAMIC CAPACITOR	 	<ul style="list-style-type: none"> ❖ Advanced dielectric materials ❖ Wide capacitance range up to 15μF ❖ Higher voltage rating in smaller case size ❖ Voltage rating of 100V, 250V, 450V, and 630V ❖ High mechanical strength ❖ Excellent DC bias properties 	<ul style="list-style-type: none"> ❖ Case Size: 0402 – 2220 ❖ Temperature Characteristics: CH, JB, C0G, X5R, X6S, X7R, X7S, X7T ❖ Voltage: 100V - 630V ❖ Cap Range: Up to 15μF
	HIGH VOLTAGE CERAMIC CAPACITOR	 	<ul style="list-style-type: none"> ❖ Up to 3000V rated voltage ❖ Wide case size offering 1206 to 2220 ❖ Improved withstanding voltage characteristics ❖ Low ESR at high frequency ❖ Low dielectric constant ❖ Complies with ISO-8802-3 required for LAN 	<ul style="list-style-type: none"> ❖ Case Size: 1206 – 2220 ❖ Temperature Characteristics: CH, JB, C0G, X7R, X7S ❖ Voltage: 1,000V - 3,000V ❖ Cap Range: Up to 47nF
	HIGH TEMP. CERAMIC CAPACITOR	 	<ul style="list-style-type: none"> ❖ Stable temperature characteristics (15%) up to 150$^{\circ}$C ❖ Highly precise temperature characteristics (\pm7.5%) up to 125$^{\circ}$ C ❖ Available in both class I C0G and Class II X8R 	<ul style="list-style-type: none"> ❖ Case Size: 0402 – 2220 ❖ Temperature Characteristics: NP0, X8R ❖ Voltage: 16V - 100V ❖ Cap Range: Up to 10μF
	MEGACAP TYPE CERAMIC CAPACITOR	 	<ul style="list-style-type: none"> ❖ Twice the capacitance on single capacitor foot print ❖ Lower ESR and ESL than Al caps ❖ Capable of absorbing thermal and mechanical stress ❖ Improved heat generation by ripple current ❖ Improved vibration performance 	<ul style="list-style-type: none"> ❖ Case Size: Single: 32K, 45K, 57K / Double: 45N, 57N ❖ Temperature Characteristics: X5R, X7R, X7S, X7T ❖ Voltage: 16V - 630V ❖ Cap Range: Up to 100μF
	SOFT TERM. CERAMIC CAPACITOR	 	<ul style="list-style-type: none"> ❖ Improved board bending resistance, drop impact resistance, thermal shock resistance, and heat cycle properties ❖ Conductive resin absorb external stress to protect solder joint parts and capacitor body ❖ RoHS, WEE, and REACH compliant 	<ul style="list-style-type: none"> ❖ Case Size: 0805 – 3025 ❖ Temperature Characteristics: JB, C0G, X5R, X7R, X7S, X7T, X8R ❖ Voltage: 6.3V - 3,000V ❖ Cap Range: Up to 100μF
	OPEN MODE CERAMIC CAPACITOR	 	<ul style="list-style-type: none"> ❖ Increase resistance to mechanical bending, temperature cycle, vibration, and electrical stresses ❖ Wider distance between the end of the opposite electrode and the termination ❖ Reduces the risk of short circuit failures ❖ X7R and X8R temperature ranges 	<ul style="list-style-type: none"> ❖ Case Size: 0805 – 2220 ❖ Temperature Characteristics: X7R, X8R ❖ Voltage: 16V - 630V ❖ Cap Range: Up to 22μF
	2in1 / 4in1 ARRAY CERAMIC CAPACITOR	 	<ul style="list-style-type: none"> ❖ Available as 2-in-1 and 4-in-1 package ❖ Reduced PCB space and mounting time ❖ Unique electrode construction reduces crosstalk ❖ 2-in-1 design also available in soft termination 	<ul style="list-style-type: none"> ❖ Case Size: 2in1: N27, M25, L22/4in1: L44, A43 ❖ Temperature Characteristics: CH, JB, C0G, X5R, X7R, X8R ❖ Voltage: 6.3V - 100V ❖ Cap Range: Up to 2.2μF
	LOW PROFILE CERAMIC CAPACITOR		<ul style="list-style-type: none"> ❖ Available in three case sizes (0402, 0603, 0805) and as thin as 0.19mm ❖ Capacitance offering from 0.22μF and up to 10μF ❖ Ideal for height-restricted applications such as mobile phone and BGA under mounting 	<ul style="list-style-type: none"> ❖ Case Size: 0201 – 0805 ❖ Temperature Characteristics: JB, X5R, X6S, X7R, X7S ❖ Voltage: 4V - 25V ❖ Cap Range: Up to 10μF



Features

Characteristics

	REVERSED GEOMETRY CERAMIC CAPACITOR		<ul style="list-style-type: none"> ❖ Flipped geometry provides low inductance (less than 400 pH) ❖ Allows adequate high frequency current to IC ❖ Provides stabilization of power line voltage ❖ High frequency noise suppression 	<ul style="list-style-type: none"> ❖ Case Size: 0204 – 0612 ❖ Temperature Characteristics: JB, X5R, X6S, X7R, X7S ❖ Voltage: 2.5V - 50V ❖ Cap Range: Up to 10μF
	ULTRA LOW INDUCTANCE CERAMIC CAPACITOR		<ul style="list-style-type: none"> ❖ Unique internal structure with inductance less than 150 pH ❖ Ultra-low ESL is created by alternating the flow of current so the magnetic fields cancel out. ❖ Contains no lead and supports lead-free soldering 	<ul style="list-style-type: none"> ❖ Case Size: 0603 – 1206 ❖ Temperature Characteristics: X6S, X7R, X7S ❖ Voltage: 4V - 10V ❖ Cap Range: Up to 6.8μF
	CONDUCTIVE EPOXY CERAMIC CAPACITOR		<ul style="list-style-type: none"> ❖ AgPdCu termination for conductive glue mounting ❖ Reduce risk of silver migration ❖ Improved mechanical/thermal strength when use with conductive glue ❖ AEC Q-200 compliant ❖ RoHS, WEE, and REACH compliant 	<ul style="list-style-type: none"> ❖ Case Size: 0402 – 1210 ❖ Temperature Characteristics: C0G, X7R, X8R ❖ Voltage: 16V - 100V ❖ Cap Range: Up to 10μF
	SERIAL DESIGN CERAMIC CAPACITOR		<ul style="list-style-type: none"> ❖ Improved bending resistance (Board Flex Resistance) ❖ Improved temperature cycle performance ❖ Allow space reduction on PCB ❖ Ultra high reliability (series cap + soft termination) ❖ RoHS, WEE, and REACH compliant 	<ul style="list-style-type: none"> ❖ Case Size: 0603 – 0805 ❖ Temperature Characteristics: X7R ❖ Voltage: 50V - 100V ❖ Cap Range: Up to 100nF
	ESD PROTECTION CERAMIC CAPACITOR		<ul style="list-style-type: none"> ❖ Compliant with the IEC 61000-4-2 standard for ESD immunity ❖ Available with C0G and NP0 thermal characteristics ❖ Stable capacitance values regardless of DC bias, temperature or aging effects ❖ Qualified to AEC-Q200 	<ul style="list-style-type: none"> ❖ Case Size: 0603 ❖ Temperature Characteristics: C0G, NP0 ❖ Voltage: 100V ❖ Cap Range: 1nF - 10nF ❖ ESD rating up to 30kV
	HIGH RELIABILITY CERAMIC CAPACITOR		<ul style="list-style-type: none"> ❖ Extensive testing to ensure higher reliability ❖ Reliability tests based on MIL-STD requirements ❖ Sigma Report (Enhanced CoC) documentation is provided for each CGJ lot ❖ Optional UHF RFID tag available ❖ Tamper proof seal for enhance anti-counterfeit 	<ul style="list-style-type: none"> ❖ Case Size: 0402 – 1210 ❖ Temperature Characteristics: C0G, X7R, X7S, X7T ❖ Voltage: 6.3V - 500V ❖ Cap Range: Up to 10μF ❖ Can be used as Commercial-off-the-Shelf (COTS)
	RADIAL LEAD TYPE CERAMIC CAPACITOR	 	<ul style="list-style-type: none"> ❖ Provides large electrostatic capacity ❖ High level of reliability under specified conditions ❖ Small residual inductance ❖ Provides good frequency characteristics ❖ Leads are formed with a "kink" to achieve consistent insertion heights for improved solderability 	<ul style="list-style-type: none"> ❖ Case Size: FK18, FK14, FK16, FK11, FK28, FK24, FK26, FK20, FK22 ❖ Temperature Characteristics: C0G, X5R, X7R, X7S ❖ Voltage: 6.3V - 630V ❖ Cap Range: Up to 100μF
	LEADED DISC TYPE CERAMIC CAPACITOR	 	<ul style="list-style-type: none"> ❖ TDK proprietary material provide low dissipation factor ❖ Compatible with halogen-free external resin coating ❖ Flame-resistant reinforced outer insulation prevents fires, electrical shock, and other potential hazards ❖ X1/Y2 Insulation Sub Class for "Line to Ground" and "Across the Line" Applications 	<ul style="list-style-type: none"> ❖ Case Size: 7mm to 16.5mm diameter ❖ Temperature Characteristics: SL, Z5U, B, E, F, R ❖ Voltage: 400V_{AC}, 1KV_{DC} - 6KV_{DC} ❖ Cap Range: Up to 10nF
	ULTRA HIGH VOLTAGE CERAMIC CAPACITOR		<ul style="list-style-type: none"> ❖ Available for power circuit breakers, distribution lines, and high voltage power supply/laser applications ❖ Voltage rating up to 50kV DC and 28KV_{rms} AC ❖ Excellent withstanding voltage rating with up to 1.5xRV with no breakdown (60s, in oil) 	<ul style="list-style-type: none"> ❖ Case Size: Diameter from 16mm to 60mm ❖ Temperature Characteristics: C0G, Y5P, Y5S, Z5T ❖ Voltage: 8KV_{AC} - 28V_{AC}, 15KV_{DC} - 50KV_{DC} ❖ Cap Range: Up to 7nF

C 3 2 1 6 X 7 R 1 H 1 0 5 K 1 6 0 A E

Series Name

Series Name	Description
C	General Purpose
CKC	Array Capacitor
CKG	MEGACAP Type
CLL	Ultra Low Inductance

Case Size Code

Unit: mm	C	CKC	CKG	CLL
0.40 x 0.20	0402			
0.50 x 1.00	0510			
0.60 x 0.30	0603			
0.80 x 1.60	0816			
0.90 x 0.60		N27		
1.00 x 0.50	1005			
1.25 x 2.00	1220			
1.37 x 1.00		M25		
1.60 x 0.80	1608			C1A
1.60 x 3.20	1632			
2.00 x 1.25	2012	L22 L44		E1A
3.20 x 1.60	3216	A43		G1A
3.20 x 2.50	3225			
3.80 x 2.90			32K	
4.50 x 2.00	4520			
4.50 x 3.20	4532			
5.50 x 4.00			45K/N	
5.70 x 5.00	5750			
6.50 x 5.50			57K/N	
7.50 x 6.30	7563			

Temperature Characteristics

	Temperature	Tolerance
CH	-25°C to +85°C	0±60ppm/°C
COG	-55°C to +125°C	0±30ppm/°C
NPO	-55°C to +150°C	0±30ppm/°C
JB	-25°C to +85°C	±10%
X5R	-55°C to +85°C	±15%
X6S	-55°C to +105°C	±22%
X7R	-55°C to +125°C	±15%
X7S	-55°C to +125°C	±22%
X7T	-55°C to +125°C	+22/-33%
X8R	-55°C to +150°C	±15%

Nominal Capacitance (pF)

The capacitance is expressed in three digit codes and in units of pico Farads (pF). The first and second digits identify the first and second significant figures of the capacitance. The third digit identifies the multiplier. R designates a decimal point.

Ex. 0R2 = 0.2pF; 103 = 10,000pF; 105 = 1,000,000pF = 1,000nF = 1μF

Packaging Code

Packaging Code	Description
A	7" Reel / 4mm Pitch
B	7" Reel / 2mm Pitch
D	13" Reel / 4mm Pitch
E	13" Reel / 2mm Pitch
J	13" Reel / 8mm Pitch
K	7" Reel / 8mm Pitch
L	13" Reel / 12mm Pitch

Special Code

Special Code	Description
E	Soft Termination
F	Hi-Q (Std Design)
G	Hi-Q (New Design)
H	MEGACAP (Std)
J	MEGACAP (Auto)
K	Soft Term Array (Std)
L	Soft Term Array (Auto)
M	Open Mode

Capacitance Tolerance

Capacitance Tolerance	Description
W	±0.05 pF
B	±0.10 pF
C	±0.25 pF
D	±0.50 pF
E	±0.20 pF
F	±1%
G	±2%
J	±5%
K	±10%
M	±20%

Thickness Code

Thickness Code	Description
020	0.20 mm
030	0.30 mm
045	0.45 mm
050	0.50 mm
055	0.55 mm
060	0.60 mm
070	0.70 mm
080	0.80 mm
085	0.85 mm
100	1.00 mm
110	1.10 mm
115	1.15 mm
125	1.25 mm
130	1.30 mm
160	1.60 mm
200	2.00 mm
230	2.30 mm
250	2.50 mm
280	2.80 mm
290	2.90 mm
320	3.20 mm
335	3.35 mm
500	5.00 mm

Rated Voltage Code

	A	C	D	E	F	G	H	J	V	W
0				2.5V		4V		6.3V		
1	10V	16V		25V			50V		35V	
2	100V		200V	250V				630V	350V	450V
3	1KV		2KV		3KV					

C G A 5 L 3 X 7 R 1 H 1 0 5 K 1 6 0 A E

Series Name

Series Name	Description
CGA	Automotive Grade
CGB	Low Profile
CGJ	High Reliability Grade
CEU	Serial Design

Case Size Code

Unit: mm	CGA	CGB	CGJ	CEU
0.60 x 0.30	1			
1.00 x 0.50	2	2	2	
1.60 x 0.80	3	3	3	3
2.00 x 1.25	4	4	4	4
3.20 x 1.60	5		5	
3.20 x 2.50	6			
4.50 x 2.00	7			
4.50 x 3.20	8			
5.70 x 5.00	9			

Life Test Condition

Life Test Condition	Description
1	1.0 x Rated Voltage
2	2.0 x Rated Voltage
3	1.5 x Rated Voltage
4	1.2 x Rated Voltage
A	ESD Rating

Temperature Characteristics

	Temperature	Tolerance
COG	-55°C to +125°C	0±30ppm/°C
NPO	-55°C to +150°C	0±30ppm/°C
JB	-25°C to +85°C	±10%
X5R	-55°C to +85°C	±15%
X6S	-55°C to +105°C	±22%
X7R	-55°C to +125°C	±15%
X7S	-55°C to +125°C	±22%
X7T	-55°C to +125°C	+22/-33%
X8R	-55°C to +150°C	±15%

Capacitance Tolerance

Capacitance Tolerance	Description
C	±0.25 pF
D	±0.50 pF
F	±1%
J	±5%
K	±10%
M	±20%

Packaging Code

Packaging Code	Description
A	7" Reel / 4mm Pitch
B	7" Reel / 2mm Pitch
K	7" Reel / 8mm Pitch

Special Code

Special Code	Description
D	Conductive Epoxy
E	Soft Termination
M	Open Mode

Nominal Capacitance (pF)

The capacitance is expressed in three digit codes and in units of pico Farads (pF). The first and second digits identify the first and second significant figures of the capacitance. The third digit identifies the multiplier. R designates a decimal point.

Ex. 0R2 = 0.2pF; 103 = 10,000pF; 105 = 1,000,000pF = 1,000nF = 1μF

Rated Voltage Code

	A	C	D	E	F	G	H	J	V	W
0						4V		6.3V		
1	10V	16V		25V			50V		35V	
2	100V		200V	250V			500V	630V		450V
3	1KV		2KV		3KV					

Thickness Code

Thickness Code	Description
019	0.19 mm
030	0.30 mm
033	0.33 mm
050	0.50 mm
055	0.55 mm
060	0.60 mm
070	0.70 mm
080	0.80 mm
085	0.85 mm
110	1.10 mm
115	1.15 mm
125	1.25 mm
130	1.30 mm
160	1.60 mm
200	2.00 mm
230	2.30 mm
250	2.50 mm
280	2.80 mm
320	3.20 mm

Thickness Code

Thickness Code	Description
T	0.19 mm
A	0.30 mm
B	0.50 mm
C	0.60 mm
E	0.80 mm
F	0.85 mm
G	1.10 mm
H	1.15 mm
J	1.25 mm
K	1.30 mm
L	1.60 mm
M	2.00 mm
N	2.30 mm
P	2.50 mm
Q	2.80 mm
R	3.20 mm

FK 28 C0G 1H 101 J

Series Name	
	Description
FK	MLCC with Dipped Radial Lead

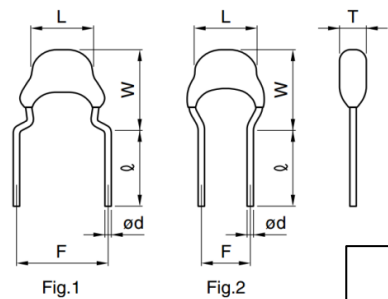

Dimension Code (Dimensions in mm)							
Type	L max.	W max.	T max.	F	l	ød	Fig
28	4	5.5	2.5	5.0±1.0	7±2	0.5+0.1,-0.03	1
24	4.5	5.5	2.5	5.0±1.0	7±2	0.5+0.1,-0.03	1
26	5.5	6	3.5	5.0±1.0	7±2	0.5+0.1,-0.03	1
20	5.5	7	4	5.0±1.0	7±2	0.5+0.1,-0.03	1
22	7.5	8	4	5.0±1.0	7±2	0.5+0.1,-0.03	1
18	4	5.5	2.5	2.5±0.8	5+3,-1	0.5+0.1,-0.03	2
14	4.5	5.5	2.5	2.5±0.8	5+3,-1	0.5+0.1,-0.03	2
16	5.5	6	3.5	2.5±0.8	5+3,-1	0.5+0.1,-0.03	2
11	5.5	7	4	2.5±0.8	5+3,-1	0.5+0.1,-0.03	2

Temperature Characteristics		
	Temperature	Tolerance
C0G	-55°C to +125°C	0±30ppm/°C
X5R	-55°C to +85°C	±15%
X7R	-55°C to +125°C	±15%
X7S	-55°C to +125°C	±22%

Rated Voltage Code					
	A	C	E	H	J
0					6.3V
1	10V	16V	25V	50V	
2	100V		250V		630V

Capacitance Tolerance	
	Description
C	±0.25 pF
D	±0.50 pF
J	±5%
K	±10%
M	±20%

Nominal Capacitance (pF)

The capacitance is expressed in three digit codes and in units of pico Farads (pF). The first and second digits identify the first and second significant figures of the capacitance. The third digit identifies the multiplier. R designates a decimal point.

Ex. 0R2 = 0.2pF; 103 = 10,000pF; 105 = 1,000,000pF = 1,000nF = 1µF

CC 45 SL 3AD 101 J Y N N A

Series Name	
	Description
CC	HiVolt Class 1 Disc Type
CK	HiVolt Class 2 Disc Type
CD	X1Y1 Safety Cap
CS	X1Y2 Safety Cap

Type / Diameter	
	Description
45	HV DISC
70	7.0 mm
75	7.5 mm
85	8.5 mm
90	9.0 mm
95	9.5 mm
10	10.0 mm
11	10.5 mm
12	11.5 mm
13	12.5 mm
14	13.5 mm
15	14.5 mm
16	15.5 mm
17	16.5 mm

Temperature Characteristics		
	Temperature	Tolerance
SL	+20°C to +85°C	+350 to -1000ppm/°C
Z5U	+10°C to +85°C	+22/-56%
-B	-25°C to +85°C	±10%
-E	-25°C to +85°C	+20/-55%
-F	-25°C to +85°C	+30/-80%
-R	-25°C to +125°C	+15/-30%

Compatible Code	
	Description
-	Halogen
A	Halogen-Free

Application Code	
	Description
N	General Purpose
S	Safety Application
R	Low Dissipation

Lead Style	
	Description
G	Vertical Kink Long
N	Vertical Kink Short
V	Vertical Kink Taping

Rated Voltage	
	Description
2GA	400 VAC
3AD	1,000 VDC
3DD	2,000 VDC
3FD	3,000 VDC
3JD	6,000 VDC

Nominal Capacitance (pF)

The capacitance is expressed in three digit codes and in units of pico Farads (pF). The first and second digits identify the first and second significant figures of the capacitance. The third digit identifies the multiplier. R designates a decimal point.

Ex. 0R2 = 0.2pF; 103 = 10,000pF; 105 = 1,000,000pF = 1,000nF = 1µF

Capacitance Tolerance	
	Description
C	±0.25 pF
D	±0.50 pF
J	±5%
K	±10%
M	±20%
Z	+80/-20%

JIS Grade	
	Description
-	N/A
A	Automotive
Y	Safety Class

GENERAL VOLTAGE MULTILAYER CERAMIC CAPACITOR



Series Overview

TDK General Voltage series offers high capacitance MLCC achieved through precision technologies by enabling the use of multiple thinner ceramic dielectric layers. TDK advanced manufacturing process offers MLCC with monolithic structure and superior mechanical strength as well as a high level of reliability. Composed of only ceramics and base metals, these capacitors provide extremely dependable performance, exhibiting virtually no degradation even when subjected to temperature extremes. Low stray capacitance ensures high conformity with nominal values, thereby simplifying the circuit design process. Owing to their low ESR and excellent frequency characteristics, these products are optimally suited for a variety of application.

Basic Design Construction

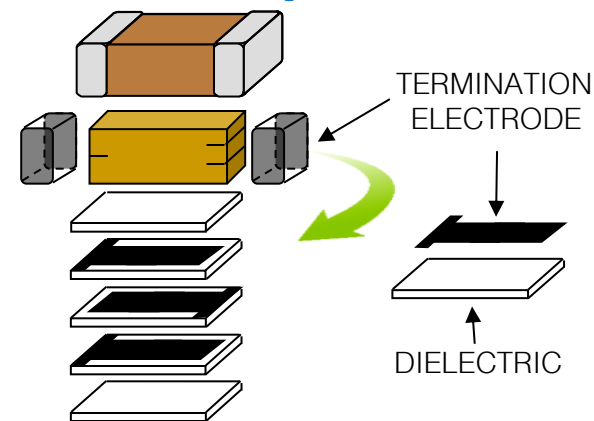

Applications

- COMMERCIAL GRADE
- AUTOMOTIVE GRADE
- HIGH RELIABILITY

Design Advantage

- ❖ Excellent DC bias characteristics
- ❖ Wide case size: 01005 to 2220
- ❖ Capacitance range up to 100uF
- ❖ Voltages up to 50V
- ❖ CDF-AEC-Q200 compliant (automotive)

Design Questions

- ❖ Do your designs include:
 - ✓ General electronics?
 - ✓ Mobile communication devices?
 - ✓ Lap-tops, tablets, PCs and servers?
 - ✓ Power Supplies?
 - ✓ Hybrid Circuits?
- ❖ Do you need auto grade?
- ❖ Do you need reliability and quality?

Characteristics

Case Size	Voltage	Cap Range
C0402 / 01005	4 - 16V	0.5pF - 220nF
C0603 / 0201	4 - 50V	0.5pF - 2.2uF
C1005 / 0402	4 - 50V	0.5pF - 10uF
C1608 / 0603	4 - 50V	0.5pF - 22uF
C2012 / 0805	4 - 50V	1nF - 47uF
C3216 / 1206	4 - 50V	3.9nF - 100uF
C3225 / 1210	4 - 50V	22nF - 100uF
C4532 / 1812	6.3 - 50V	47pF - 100uF
C5750 / 2220	6.3 - 50V	4.7uF - 100uF
CGA1 / 0201	6.3 - 50V	1pF - 10nF
CGA2 / 0402	6.3 - 50V	1pF - 470nF
CGA3 / 0603	6.3 - 50V	1pF - 4.7uF
CGA4 / 0805	6.3 - 50V	1nF - 10uF
CGA5 / 1206	6.3 - 50V	4.7nF - 22uF
CGA6 / 1210	6.3 - 50V	22nF - 47uF
CGA8 / 1812	16 - 50V	47nF - 22uF
CGA9 / 2220	16 - 50V	4.7uF - 47uF

Ordering Information

COMMERCIAL GRADE

C	3216	X7R	1C	106	K	160	A	C
Series Name	Case Size	Temperature Characteristics	Voltage Code	Cap Code	Cap Tolerance	Thickness	Packaging Code	Special Code
C	0402 0603 1005 1608 2012 3216 3225 4532 5750	COG (0±30ppm/°C) CH (0±60ppm/°C) JB (±10%) X5R (±15%) X6S (±22%) X7R (±15%) X7S (±22%)	0G = 4V 0J = 6.3V 1A = 10V 1C = 16V 1E = 25V 1V = 35V 1H = 50V	0R5 to 107	B = ± 0.10pF C = ± 0.25pF D = ± 0.50pF F = ±1% G = ±2% J = ±5% K = ±10% M = ±20%	020 = 0.20mm 030 = 0.30mm 050 = 0.50mm 060 = 0.60mm 080 = 0.80mm 085 = 0.85mm 115 = 1.15mm 125 = 1.25mm 130 = 1.30mm 160 = 1.60mm 200 = 2.00mm 230 = 2.30mm 250 = 2.50mm 280 = 2.80mm 320 = 3.20mm	A = 7" Reel/ 4mm Pitch B = 7" Reel/ 2mm Pitch K = 7" Reel/ 8mm Pitch	A = Internal B = Internal C = Internal

AUTOMOTIVE GRADE

CGA	5	L	1	X7R	1C	106	K	160	A	C
Series Name	Case Size	Thickness Code	Life Test Condition	Temperature Characteristics	Voltage Code	Cap Code	Cap Tolerance	Thickness	Packaging Code	Special Code
CGA	1 = C0603 2 = C1005 3 = C1608 4 = C2012 5 = C3216 6 = C3225 8 = C4532 9 = C5750	A = 0.30mm B = 0.50mm C = 0.60mm E = 0.80mm F = 0.85mm H = 1.15mm J = 1.25mm L = 1.60mm M = 2.00mm N = 2.30mm P = 2.50mm Q = 2.80mm R = 3.20mm	1 = 1xRV 2 = 2xRV 3 = 1.5xRV	COG (0±30ppm/°C) X5R (±15%) X7R (±15%) X7S (±22%)	0J = 6.3V 1A = 10V 1C = 16V 1E = 25V 1V = 35V 1H = 50V	010 to 156	C = ± 0.25pF D = ± 0.50pF J = ±5% K = ±10% M = ±20%	030 = 0.30mm 050 = 0.50mm 060 = 0.60mm 080 = 0.80mm 085 = 0.85mm 115 = 1.15mm 125 = 1.25mm 160 = 1.60mm 200 = 2.00mm 230 = 2.30mm 250 = 2.50mm 280 = 2.80mm 320 = 3.20mm	A = 7" Reel/ 4mm Pitch B = 7" Reel/ 2mm Pitch K = 7" Reel/ 8mm Pitch	A = Internal B = Internal C = Internal

MID VOLTAGE MULTILAYER CERAMIC CAPACITOR



Applications

- COMMERCIAL GRADE
- AUTOMOTIVE GRADE
- HIGH RELIABILITY

Design Advantage

- ❖ 100V to 630V rated voltage
- ❖ Class I & II characteristics
- ❖ Wide case size: 0402 to 2220
- ❖ Capacitance range up to 15uF
- ❖ Temperature range -55°C to +125°C
- ❖ Excellent DC bias characteristics

Design Questions

- ❖ Are you designing a snubber?
- ❖ Are you designing I/O filters?
- ❖ Do you need auto grade?
- ❖ Do you design lighting?
- ❖ Are you designing modems?

Characteristics

Case Size	Voltage	Cap Range
C1005 / 0402	100V	100pF - 10nF
C1608 / 0603	100 - 250V	1pF - 100nF
C2012 / 0805	100 - 450V	100pF - 1uF
C3216 / 1206	100 - 630V	100pF - 3.3uF
C3225 / 1210	100 - 630V	3.9nF - 4.7uF
C4532 / 1812	100 - 630V	8.2nF - 4.7uF
C5750 / 2220	100 - 630V	68nF - 15uF
CGA2 / 0402	100V	100pF - 10nF
CGA3 / 0603	100 - 250V	1pF - 100nF
CGA4 / 0805	100 - 250V	100pF - 1uF
CGA5 / 1206	100 - 630V	100pF - 3.3uF
CGA6 / 1210	100 - 630V	3.9nF - 4.7uF
CGA8 / 1812	100 - 630V	8.2nF - 4.7uF
CGA9 / 2220	100 - 630V	68nF - 15uF

Series Overview

With a rated voltage ranging from 100V to 630V, TDK's mid voltage multilayer ceramic chip capacitors (MLCC) use ceramic dielectric thin-layer and advanced multi-layering technologies to improve capacitance to the industry's highest levels in the mid-voltage range.

These products feature Class I & Class II temperature characteristics (operating temperature range: -55°C and up to 125°C), making them ideal for use in electric flash circuits in digital camera, higher voltage switching power supply smoothing circuits needed for industrial equipment, power factor correction, various lighting application, and general circuits that require higher voltages than traditional sub 100V rated MLCC's (see example circuit below).

HEV DC/DC Converter 300-400V

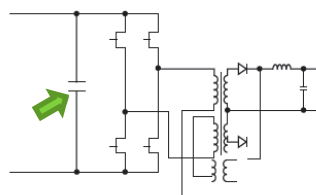

PFC Output filter 360-400V

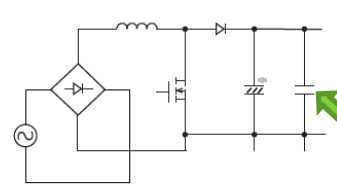

High-voltage input DC/DC 230-370V

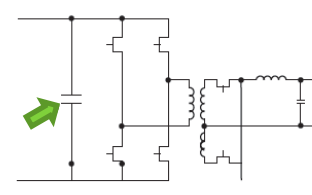

Ordering Information

COMMERCIAL GRADE

C	3225	X7R	2A	105	K	200	A	A
Series Name	Case Size	Temperature Characteristics	Voltage Code	Cap Code	Cap Tolerance	Thickness	Packaging Code	Special Code
C	1005 1608 2012 3216 3225 4532 5750	COG (0±30ppm/°C) CH (0±60ppm/°C) JB (±10%) X5R (±15%) X6S (±22%) X7R (±15%) X7S (±22%) X7T (+22/-33%)	2A = 100V 2E = 250V 2V = 350V 2W = 450V 2J = 630V	102 to 156	C = ± 0.25pF D = ± 0.50pF F = ±1% G = ±2% J = ±5% K = ±10% M = ±20%	050 = 0.50mm 060 = 0.60mm 080 = 0.80mm 085 = 0.85mm 115 = 1.15mm 125 = 1.25mm 130 = 1.30mm 160 = 1.60mm 200 = 2.00mm 230 = 2.30mm 250 = 2.50mm 280 = 2.80mm 320 = 3.20mm	A = 7" Reel/ 4mm Pitch B = 7" Reel/ 2mm Pitch K = 7" Reel/ 8mm Pitch	A = Internal B = Internal C = Internal

AUTOMOTIVE GRADE

CGA	9	P	3	X7S	2A	156	M	250	K	B
Series Name	Case Size	Thickness Code	Life Test Condition	Temperature Characteristics	Voltage Code	Cap Code	Cap Tolerance	Thickness	Packaging Code	Special Code
CGA	2 = C1005 3 = C1608 4 = C2012 5 = C3216 6 = C3225 8 = C4532 9 = C5750	B = 0.50mm C = 0.60mm E = 0.80mm F = 0.85mm H = 1.15mm J = 1.25mm K = 1.30mm L = 1.60mm M = 2.00mm N = 2.30mm P = 2.50mm R = 3.20mm	1 = 1xRV 2 = 2xRV 3 = 1.5xRV 4 = 1.2xRV	COG (0±30ppm/°C) X7R (±15%) X7S (±22%) X7T (+22/-33%)	2A = 100V 2E = 250V 2W = 450V 2J = 630V	102 to 156	C = ± 0.25pF D = ± 0.50pF J = ±5% K = ±10% M = ±20%	050 = 0.50mm 060 = 0.60mm 080 = 0.80mm 085 = 0.85mm 115 = 1.15mm 125 = 1.25mm 130 = 1.30mm 160 = 1.60mm 200 = 2.00mm 230 = 2.30mm 250 = 2.50mm 320 = 3.20mm	A = 7" Reel/ 4mm Pitch B = 7" Reel/ 2mm Pitch K = 7" Reel/ 8mm Pitch	A = Internal B = Internal C = Internal

HIGH VOLTAGE MULTILAYER CERAMIC CAPACITOR



Series Overview

With rated voltage range of 1000V to 3000V, TDK's High Voltage Series multilayer ceramic chip capacitors (MLCC) use advanced ceramic dielectric thin-layer and multi-layering technologies to offer capacitance to the industry's highest levels in the high-voltage range and improved withstanding voltage characteristics.

These products feature C0G and X7R temperature characteristics (operating temperature range: -55°C to 125°C), making them ideal for use in higher temperature circuit requirements. TDK High Voltage C series is available in 1206 to 2220 case size. Additionally, TDK High Voltage MLCC's feature substantial AC and DC breakdown voltage capabilities to ensure excellent reliability in the higher voltage applications.

Applications

- COMMERCIAL GRADE
- AUTOMOTIVE GRADE
- HIGH RELIABILITY

Design Advantage

- ❖ 1,000V to 3,000V rated voltage
- ❖ Wide case size: 1206 to 2220
- ❖ Advanced dielectric technology
- ❖ Low ESR at high frequencies
- ❖ ISO-8802-3 compliant for LAN
 - ✓ Suitable for 100 Base-T
- ❖ Temperature range -55°C to +125°C
- ❖ Excellent AC/DC voltage breakdown
- ❖ Available in Soft Termination

Design Questions

- ❖ Do you need high voltage coupling?
- ❖ Are you designing LAN products?
- ❖ Are you designing power converters?
- ❖ Do you design power supplies?
- ❖ Are you designing Ethernet switches?
- ❖ Do you design lighting ballasts?
- ❖ Are you designing industrial equipment?

Characteristics

Case Size	Voltage	Cap Range
C3216 / 1206	1K - 2KV	100pF - 2.2nF
C3225 / 1210	1K - 2KV	1nF - 4.7nF
C4520 / 1808	1K - 3KV	10pF - 4.7nF
C4532 / 1812	1K - 3KV	100pF - 10nF
C5750 / 2220	1K - 2KV	4.7nF - 47nF
CGA5 / 1206	1K - 2KV	100pF - 2.2nF
CGA6 / 1210	1K - 2KV	1nF - 4.7nF
CGA7 / 1808	1K - 3KV	10pF - 4.7nF
CGA8 / 1812	1K - 3KV	100pF - 10nF
CGA9 / 2220	1K - 2KV	4.7nF - 47nF

DC Breakdown Voltage

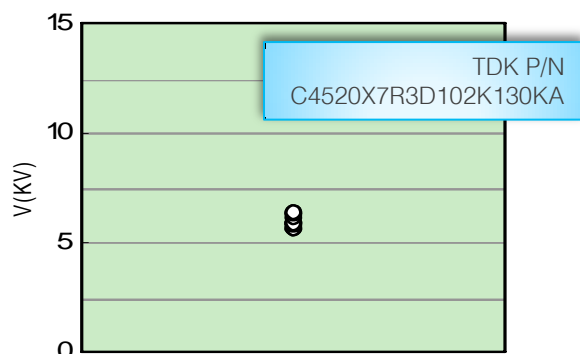

AC Breakdown Voltage

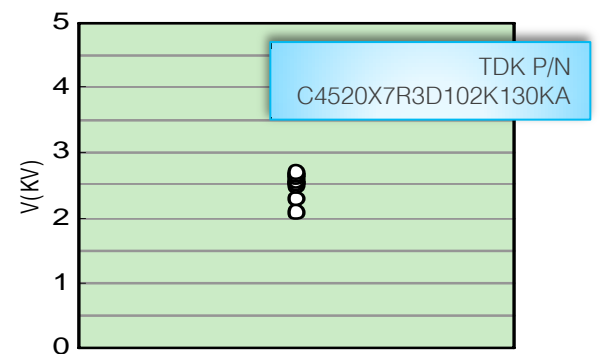

Ordering Information

COMMERCIAL GRADE

C	5750	X7S	3A	473	K	250	K	A
Series Name	Case Size	Temperature Characteristics	Voltage Code	Cap Code	Cap Tolerance	Thickness	Packaging Code	Special Code
C	3216 3225 4520 4532 5750	C0G (0±30ppm/°C) CH (0±60ppm/°C) JB (±10%) X7R (±15%) X7S (±22%)	3A = 1KV 3D = 2KV 3F = 3KV	100 to 473	F = ±1% K = ±10% M = ±20%	085 = 0.85mm 110 = 1.10mm 130 = 1.30mm 160 = 1.60mm 200 = 2.00mm 230 = 2.30mm 250 = 2.50mm	A = 7" Reel/ 4mm Pitch K = 7" Reel/ 8mm Pitch	A = Internal E = Soft Termination

AUTOMOTIVE GRADE

CGA	9	P	1	X7S	3A	473	K	250	K	A
Series Name	Case Size	Thickness Code	Life Test Condition	Temperature Characteristics	Voltage Code	Cap Code	Cap Tolerance	Thickness	Packaging Code	Special Code
CGA	5 = C3216 6 = C3225 7 = C4520 8 = C4532 9 = C5750	F = 0.85mm G = 1.10mm K = 1.30mm L = 1.60mm M = 2.00mm N = 2.30mm P = 2.50mm	1 = 1xRV	C0G (0±30ppm/°C) X7R (±15%) X7S (±22%)	3A = 1KV 3D = 2KV 3F = 3KV	100 to 473	F = ±1% K = ±10% M = ±20%	085 = 0.85mm 110 = 1.10mm 130 = 1.30mm 160 = 1.60mm 200 = 2.00mm 230 = 2.30mm 250 = 2.50mm	A = 7" Reel/ 4mm Pitch K = 7" Reel/ 8mm Pitch	A = Internal E = Soft Termination

HIGH TEMPERATURE MULTILAYER CERAMIC CAPACITOR

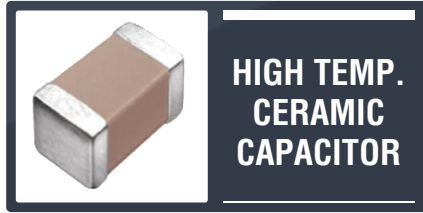

Series Overview

TDK High Temperature Series features stable temperature characteristics and higher reliability performance up to 150°C. This series is designed to meet the needs of automotive applications and/or applications which require operating conditions beyond 125°C of X7R temperature characteristics.

Temperature characteristics of capacitance for this series is stable ($\pm 15\%$) even at the higher temperature ($\sim 150^\circ\text{C}$). Temperature characteristics of capacitance shows highly precise performance (capacitance change of $\pm 7.5\%$) up to 125°C. With precise temperature characteristics, these capacitor are ideal for various high temperature applications such as solar panel inverters, measurement instruments used in high temperature environments as well as smart meter/smart grid application where extreme temperatures are common.

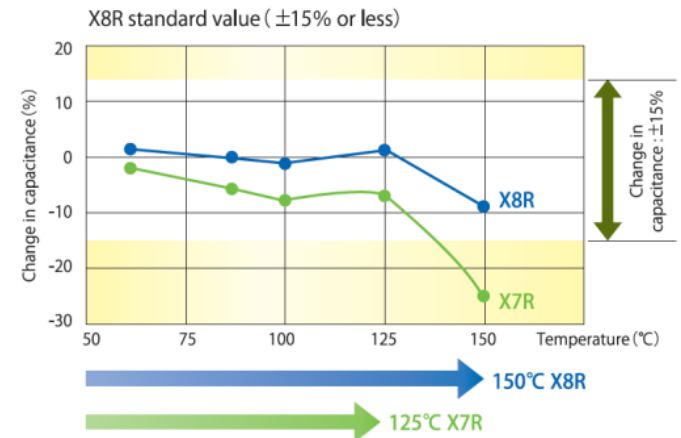

- Temperature characteristics of capacitance is stable ($\pm 15\%$) even at the higher temperature ($\sim 150^\circ\text{C}$)
- Temperature characteristics of capacitance shows highly precise performance (capacitance change of $\pm 7.5\%$) up to 125°C

Applications

- COMMERCIAL GRADE
- AUTOMOTIVE GRADE
- HIGH RELIABILITY

Design Advantage

- ❖ For temperature extremes -55 to 150°C
- ❖ Excellent temperature stability
- ❖ Robust and reliable
- ❖ Non-polarized for easy installation
- ❖ Precise temperature characteristics
- ❖ Low ESR & ESL
- ❖ CDF-AEC-Q200 compliant (automotive)
- ❖ Capacitance range 150pF to 10uF
- ❖ T/C: X8R, NP0

Design Questions

- ❖ The circuit exposed to wide temp ranges?
- ❖ Is temperature stability critical?
- ❖ Designing for under-hood auto circuits?
- ❖ Do your existing caps fail to offer stability?
- ❖ Application is down-hole oil exploration?
- ❖ Need industrial hardened performance?

Characteristics

Case Size	Voltage	Cap Range
C1005 / 0402	16 - 100V	1pF - 47nF
C1608 / 0603	16 - 100V	1pF - 470nF
C2012 / 0805	16 - 100V	1nF - 1uF
C3216 / 1206	16 - 100V	3.9nF - 4.7uF
C3225 / 1210	16 - 100V	15nF - 10uF
C4532 / 1812	50 - 100V	47nF - 22nF
C5750 / 2220	100V	150nF
CGA2 / 0402	16 - 100V	1pF - 47nF
CGA3 / 0603	16 - 100V	1pF - 470nF
CGA4 / 0805	16 - 100V	1nF - 1uF
CGA5 / 1206	16 - 100V	3.9nF - 4.7uF
CGA6 / 1210	16 - 100V	15nF - 10uF
CGA8 / 1812	50 - 100V	47nF - 22nF
CGA9 / 2220	100V	150nF

Ordering Information

COMMERCIAL GRADE

C	3225	X8R	1C	106	K	250	A	B
Series Name	Case Size	Temperature Characteristics	Voltage Code	Cap Code	Cap Tolerance	Thickness	Packaging Code	Special Code
C	1005 1608 2012 3216 3225 4532 5750	NP0 (0 \pm 30ppm/ $^\circ\text{C}$) X8R ($\pm 15\%$)	1C = 16V 1E = 25V 1H = 50V 2A = 100V	010 to 106	C = $\pm 0.25\text{pF}$ D = $\pm 0.50\text{pF}$ J = $\pm 5\%$ K = $\pm 10\%$ M = $\pm 20\%$	050 = 0.50mm 060 = 0.60mm 080 = 0.80mm 085 = 0.85mm 115 = 1.15mm 125 = 1.25mm 160 = 1.60mm 200 = 2.00mm 230 = 2.30mm 250 = 2.50mm 320 = 3.20mm	A = 7" Reel/ 4mm Pitch B = 7" Reel/ 2mm Pitch K = 7" Reel/ 8mm Pitch	A = Internal B = Internal

AUTOMOTIVE GRADE

CGA	6	P	3	X8R	1C	106	K	250	A	B
Series Name	Case Size	Thickness Code	Life Test Condition	Temperature Characteristics	Voltage Code	Cap Code	Cap Tolerance	Thickness	Packaging Code	Special Code
CGA	2 = C1005 3 = C1608 4 = C2012 5 = C3216 6 = C3225 8 = C4532 9 = C5750	B = 0.50mm C = 0.60mm E = 0.80mm F = 0.85mm H = 1.15mm J = 1.25mm L = 1.60mm M = 2.00mm N = 2.30mm P = 2.50mm R = 3.20mm	2 = 2xRV 3 = 1.5xRV	NP0 (0 \pm 30ppm/ $^\circ\text{C}$) X8R ($\pm 15\%$)	1C = 16V 1E = 25V 1H = 50V 2A = 100V	010 to 106	C = $\pm 0.25\text{pF}$ D = $\pm 0.50\text{pF}$ J = $\pm 5\%$ K = $\pm 10\%$ M = $\pm 20\%$	050 = 0.50mm 060 = 0.60mm 080 = 0.80mm 085 = 0.85mm 115 = 1.15mm 125 = 1.25mm 160 = 1.60mm 200 = 2.00mm 230 = 2.30mm 250 = 2.50mm 320 = 3.20mm	A = 7" Reel/ 4mm Pitch B = 7" Reel/ 2mm Pitch K = 7" Reel/ 8mm Pitch	A = Internal B = Internal

MEGACAP TYPE MULTILAYER CERAMIC CAPACITOR

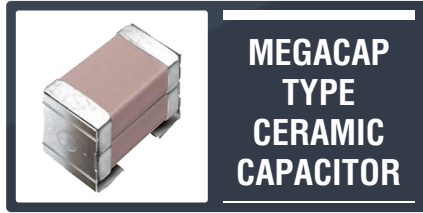

Series Overview

TDK MegaCap Type Capacitor utilizes an alloy 42 lead frame connected to the ends of MLCCs in single or double stacked (piled) configuration. The lead frame absorbs external stresses which allow a more robust performance. Effectively the lead frame allows external stresses beyond the typical allowable range for a traditional MLCC.

Mega Caps are excellent choices for high board flex applications as well as physically large boards that are highly susceptible to flexure. Other flex solutions are designed to resist short circuit but still cause the capacitor to fail intermittently or completely but the Mega Cap has a greater degree of flexure resistance without capacitor failure. Compared to electrolytic capacitors, Mega Cap offers lower ESL, ESR, and improved frequency response and since Mega Cap is an MLCC, they have no polarity. Other advantages include higher capacitance with higher voltage rating due to stacking the capacitors in parallel configuration

Applications

- COMMERCIAL GRADE
- AUTOMOTIVE GRADE
- HIGH RELIABILITY

Design Advantage

- ❖ Double-stack capacitor (single also)
- ❖ Double the capacitance in same footprint
- ❖ Designed for excessive board flex
- ❖ Excellent vibration performance
- ❖ Sn-37Pb (lead solder) compatible
- ❖ Lower ESL & ESR than ALU capacitors

Design Questions

- ❖ Do you need more capacitance?
- ❖ Do you have board flex issue?
- ❖ Do you have thermal cracking issue?
- ❖ Are you looking for better ESL or ESR?
- ❖ Do you need anti-piezoelectric solution?
- ❖ Are you replacing Ta or Al capacitors?

Characteristics

Case Size	Voltage	Cap Range
CKG32K (Single)	25 - 630V	47nF - 10uF
CKG45K (Single)	16 - 630V	0.1uF - 22uF
CKG57K (Single)	16 - 630V	0.22uF - 47uF
CKG45N (Double)	16 - 630V	0.22uF - 47uF
CKG57N (Double)	16 - 630V	0.47uF - 100uF

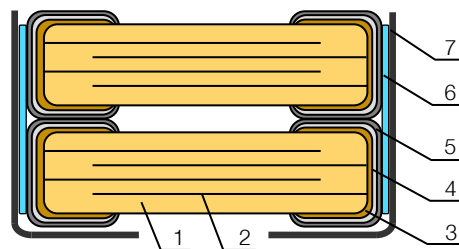

No.	NAME	MATERIAL
		Class 2
(1)	Ceramic Dielectric	BaTiO ₃
(2)	Internal Electrode	Nickel (Ni)
(3)		Copper (Cu)
(4)	Termination	Nickel (Ni)
(5)		Tin (Sn)
(6)	Metal Cap Joint	High Temp Solder
(7)	Metal Cap	42 Alloy

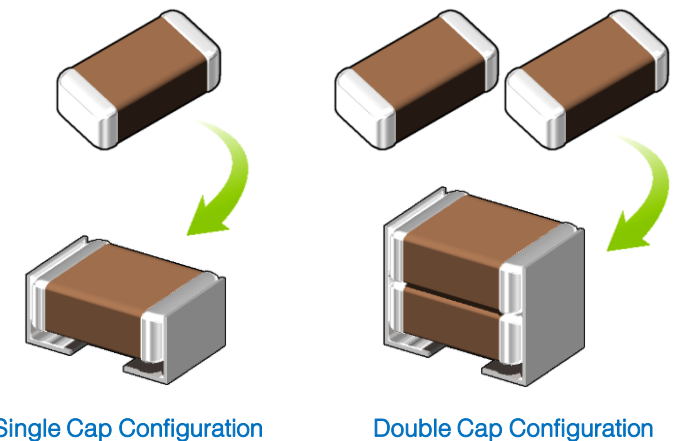

Ordering Information

COMMERCIAL & AUTOMOTIVE GRADE

Series Name	Case Size	Temperature Characteristics	Voltage Code	Cap Code	Cap Tolerance	Thickness	Packaging Code	Special Code
CKG	32K (Single) 45K (Single) 57K (Single) 45N (Double) 57N (Double)	X5R (±15%) X7R (±15%) X7S (±22%) X7T (+22/-33%)	1C = 16V 1E = 25V 1H = 50V 2A = 100V 2E = 250V 2W = 450V 2J = 630V	473 to 107	K = ±10% M = ±20%	290 = 2.90mm 335 = 3.35mm 500 = 5.00mm	A = 7" Reel/ 4mm Pitch J = 13" Reel/ 8mm Pitch	H = MEGA CAP (STD) J = MEGA CAP (AUTO)

SOFT TERMINATION MULTILAYER CERAMIC CAPACITOR



Series Overview

TDK Soft Termination Series is designed for use in applications where significant board flex may occur. Safety/critical automotive applications such as ABS, ESP, airbag, and battery line applications are common examples.

Conventional termination materials used in standard MLCCs are inflexible; therefore vibration, shock, or thermal expansion and contraction have the potential to crack or shear the solder joint between the component and the circuit board. Automotive applications, which are exposed to shock, vibration and extreme temperature swings, can result in higher failure rates in the field with conventional capacitors. TDK's new soft termination provides high resistance to mechanical and thermal stress to ensure the component can meet the requirements of automotive OEMs. Other application such as measurement instruments used in environment with frequent temperature swings can benefit as well.

Soft Termination

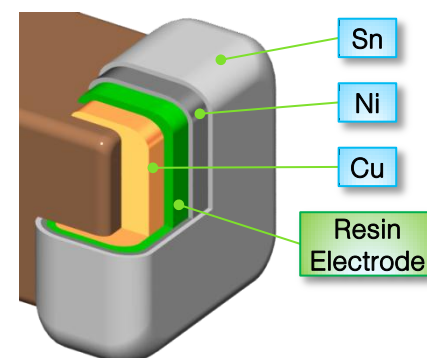

➤ A resin electrode layer between the copper base and the nickel plating of the terminal electrode absorbs bending stress from the board and suppresses the forming of solder cracks.

Applications

- COMMERCIAL GRADE
- AUTOMOTIVE GRADE
- HIGH RELIABILITY

Design Advantage

- ❖ Conductive resin soft termination
- ❖ Directs stress away from ceramic body
- ❖ Superior board flex performance
- ❖ Resistant to thermal shock
- ❖ High capacitance up to 100uF
- ❖ RoHS, WEE and REACH compliant
- ❖ CDF-AEC-Q200 compliant (automotive)

Design Questions

- ❖ Do you have excessive board flex?
- ❖ Is there excessive vibration?
- ❖ Do you have cracking from:
 - ✓ De-paneling?
 - ✓ Caps near connectors?
 - ✓ Caps near large components?

Characteristics

Case Size	Voltage	Cap Range
C1608 / 0603	50V	1nF - 100nF
C2012 / 0805	25 - 450V	10nF - 4.7uF
C3216 / 1206	25 - 2000V	470pF - 10uF
C3225 / 1210	50 - 630V	47nF - 10uF
C4520 / 1808	2000V	1nF
C4532 / 1812	250 - 3000V	330pF - 1uF
C5750 / 2220	100 - 2000V	10nF - 10uF
C7563 / 3025	16 - 50V	22uF - 100uF
CGA3 / 0603	50V	1nF - 100nF
CGA4 / 0805	25 - 450V	10nF - 4.7uF
CGA5 / 1206	25 - 2000V	470nF - 10uF
CGA6 / 1210	50 - 630V	47nF - 10uF
CGA7 / 1808	2000V	1nF
CGA8 / 1812	250 - 3000V	330pF - 1uF
CGA9 / 2220	100 - 2000V	10nF - 10uF
*CKCN27 / 0302	6.3V	100nF
CKCM25 / 0504	6.3 - 100V	10pF - 1uF
CKCL22 / 0805	6.3 - 100V	10pF - 2.2uF

* Commercial grade only

Ordering Information

COMMERCIAL GRADE

C	7563	X7S	1C	107	M	280	L	E
Series Name	Case Size	Temperature Characteristics	Voltage Code	Cap Code	Cap Tolerance	Thickness	Packaging Code	Special Code
C	1608	COG (0±30ppm/°C)	0J = 6.3V	100	F = ±1pF	045 = 0.45mm	A = 7" Reel/ 4mm Pitch	E = Soft Termination
CKC	2012	JB (±10%)	1A = 10V	to	K = ±10%	060 = 0.60mm	B = 7" Reel/ 2mm Pitch	K = Soft Termination
	3216	X5R (±15%)	1C = 16V	107	M = ±20%	080 = 0.80mm	L = 13" Reel/ 12mm Pitch	L = Soft Termination
	3225	X7R (±15%)	1E = 25V			085 = 0.85mm	K = 7" Reel/ 8mm Pitch	Array (STD)
	4520	X7S (±22%)	1V = 35V			115 = 1.15mm		
	4532	X7T (+22/-33%)	1H = 50V			125 = 1.25mm		
	5750	X8R (±15%)	2A = 100V			130 = 1.30mm		
	7563		2E = 250V			160 = 1.60mm		
	N27		2W = 450V			200 = 2.00mm		
	M25		2J = 630V			230 = 2.30mm		
	L22		3A = 1KV			250 = 2.50mm		
			3D = 2KV			280 = 2.80mm		
			3F = 3KV					

AUTOMOTIVE GRADE

CGA	6	P	3	X7S	1H	106	K	250	A	E
Series Name	Case Size	Thickness Code	Life Test Condition	Temperature Characteristics	Voltage Code	Cap Code	Cap Tolerance	Thickness	Packaging Code	Special Code
CGA	3 = C1608	F = 0.85mm	1 = 1xRV	COG (0±30ppm/°C)	1A = 10V	100	F = ±1%	060 = 0.60mm	A = 7" Reel/ 4mm Pitch	E = Soft Termination
CKC	4 = C2012	H = 1.15mm	2 = 2xRV	JB (±10%)	1C = 16V	to	K = ±10%	085 = 0.85mm	K = 7" Reel/ 8mm Pitch	L = Soft Termination
	5 = C3216	J = 1.25mm	3 = 1.5xRV	X7S (±22%)	1E = 25V	156	M = ±20%	115 = 1.15mm		Array (AUTO)
	6 = C3225	K = 1.30mm	4 = 1.2xRV	X7T (+22/-33%)	1V = 35V			125 = 1.25mm		
	7 = C4520	L = 1.60mm	N/A for CKC	X8R (±15%)	1H = 50V			130 = 1.30mm		
	8 = C4532	M = 2.00mm			2A = 100V			160 = 1.60mm		
	9 = C5750	N = 2.30mm			2E = 250V			200 = 2.00mm		
	M25	P = 2.50mm			2W = 450V			230 = 2.30mm		
	L22	N/A for CKC			2J = 630V			250 = 2.50mm		
					3A = 1KV					
					3D = 2KV					
					3F = 3KV					

OPEN MODE MULTILAYER CERAMIC CAPACITOR

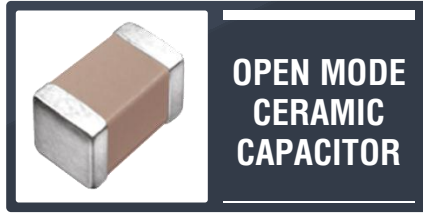

**OPEN MODE
CERAMIC
CAPACITOR**



Series Overview

TDK Open Mode Series MLCC is designed to avoid a short circuit when excessive board flex stress causes the ceramic component to crack. By utilizing a unique internal electrode design, the counter electrode avoids the board flex's typical crack path.

Composed of only ceramics and metals, Open Mode Series provides extremely dependable performance, exhibiting virtually no degradation, even when subjected to temperature extremes (X7R and X8R temperature ranges are available). TDK Open Mode MLCCs are available in case sizes 0805, 1206, 1210, 1812, and 2220.

Standard Design

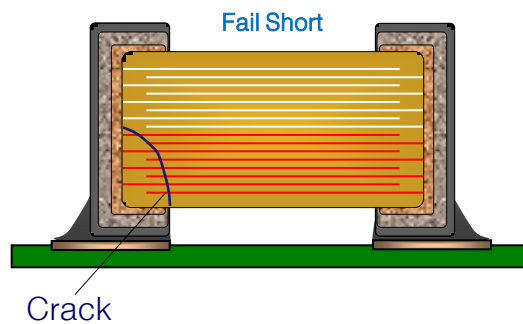

Open Mode Design

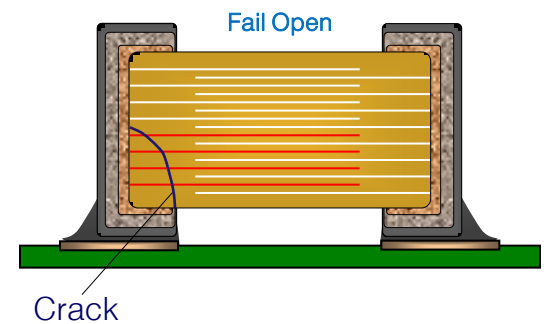

➤ Open Mode capacitor is designed with wider gap between the terminal and the internal electrodes to help reduce the risk of short circuit in the event of capacitor cracking due to mechanical stress such as board bending.

Applications

- COMMERCIAL GRADE
- AUTOMOTIVE GRADE
- HIGH RELIABILITY

Design Advantage

- ❖ Reduced risk of short circuit failures
- ❖ Unique electrode design
- ❖ Resistant to excessive board flex
- ❖ Resistant to temp cycling & vibration
- ❖ Temperature range -55°C to +150°C
- ❖ CDF-AEC-Q200 compliant (automotive)

Design Questions

- ❖ Do you have a battery direct circuit?
- ❖ Is open-circuit safety required?
- ❖ Do you have a high current circuit?
- ❖ Do you have excessive board flex?
- ❖ Are you designing a power bus circuit?
- ❖ Is this a safety related circuit?
- ❖ Do you need automotive grade?

Characteristics

Case Size	Voltage	Cap Range
C2012 / 0805	50 - 250V	1nF - 100nF
C3216 / 1206	16 - 630V	1nF - 4.7uF
C3225 / 1210	16 - 630V	47nF - 4.7uF
C4532 / 1812	16 - 630V	68nF - 10uF
C5750 / 2220	16 - 630V	150nF - 22uF
CGA4 / 0805	50V	47nF - 100nF

Ordering Information

COMMERCIAL GRADE

C	5750	X7R	1C	226	M	280	K	M
Series Name	Case Size	Temperature Characteristics	Voltage Code	Cap Code	Cap Tolerance	Thickness	Packaging Code	Special Code
C	2012 3216 3225 4532 5750	X7R (±15%) X8R (±15%)	1C = 16V 1E = 25V 1H = 50V 2A = 100V 2E = 250V 2J = 630V	102 to 106	K = ±10% M = ±20%	085 = 0.85mm 115 = 1.15mm 125 = 1.25mm 130 = 1.30mm 160 = 1.60mm 200 = 2.00mm 230 = 2.30mm 250 = 2.50mm 280 = 2.80mm	A = 7" Reel/ 4mm Pitch K = 7" Reel/ 8mm Pitch	M = Open Mode

AUTOMOTIVE GRADE

CGA	4	J	3	X7R	1H	104	K	125	A	M
Series Name	Case Size	Thickness Code	Life Test Condition	Temperature Characteristics	Voltage Code	Cap Code	Cap Tolerance	Thickness	Packaging Code	Special Code
CGA	4 = C2012	F = 0.85mm J = 1.25mm	2 = 2xRV	X7R (±15%) X8R (±15%)	1H = 50V	223 to 104	K = ±10%	085 = 0.85mm 125 = 1.25mm	A = 7" Reel/ 4mm Pitch	M = Open Mode

2in1/4in1 ARRAY MULTILAYER CERAMIC CAPACITOR

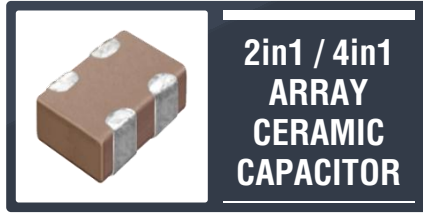

Series Overview

TDK CKC Series Array Capacitor offers multiple multilayer ceramic chip capacitors (MLCCs) in a single compact package. TDK's unique design offers lower cross talk which truly function as separate individual capacitors in a single package. Arrays are offered in 2-in-1 and 4-in-1 package styles.

Capacitor arrays are mainly used to reduce board space and component count as well as reducing placement time and warehouse/storage space. Capacitor arrays are also commonly used for noise decoupling. Today's higher density circuits, increased feature designs, and smaller product sizes force designers to find ways to reduce component count simply due to the fact of no available board space. TDK's Array caps offer to fix this problem with our advance layering technique and innovative multilayer capacitor design. Capacitor arrays also allow decoupling capacitors to be placed closer to high speed ICs/ASICs which reduces trace inductance.

Applications

- COMMERCIAL GRADE
- AUTOMOTIVE GRADE
- HIGH RELIABILITY

Design Advantage

- ❖ Available in 2 and 4 element arrays
- ❖ 2-Element for auto & commercial
- ❖ 4-Element for commercial
- ❖ Soft termination available for 2in1
- ❖ Board space saving design
- ❖ Capacitance range of 10pF to 1uF
- ❖ Rated voltage 6.3V to 100V
- ❖ T/Cs: X5R, X7R, C0G

Design Questions

- ❖ Are you trying to reduce:
 - ✓ Board space?
 - ✓ Component count?
- ❖ Are you designing a high density connector?
- ❖ Are you designing a cell phone interface?
- ❖ Do you have board flex near connectors?
- ❖ Do you need automotive grade arrays?

Characteristics

Case Size	Voltage	Cap Range
CKCN27	6.3V	100nF
CKCM25	6.3 - 50V	10pF - 1uF
CKCL22	6.3 - 100V	10pF - 2.2uF
CKCN27*K	6.3V	100nF
CKCM25*K	25 - 100V	10pF - 1uF
CKCL22*K	10 - 100V	10pF - 2.2uF
CKCM25*L	25 - 100V	10pF - 10nF
CKCL22*L	10 - 100V	10pF - 220nF
CKCL44	6.3 - 50V	10pF - 100nF
CKCA43	6.3 - 100V	10pF - 1uF

Array Capacitor Design Concept

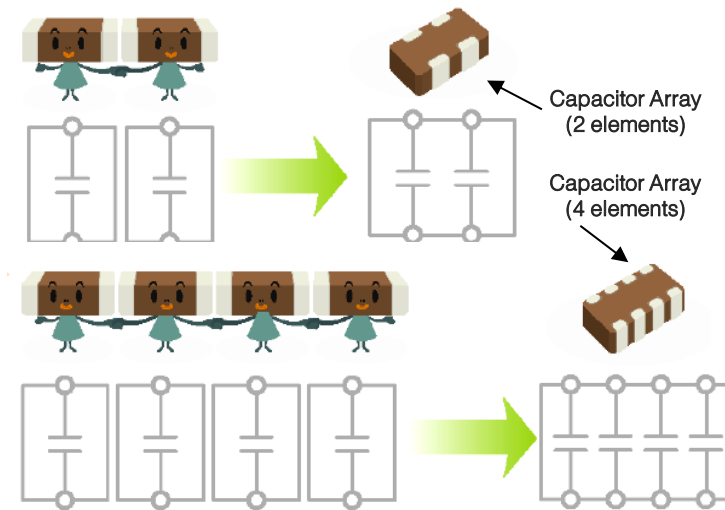

➤ Array Capacitor combines multiple capacitor into a single chip. They are effective in reducing placement time and cost.

Soft Termination

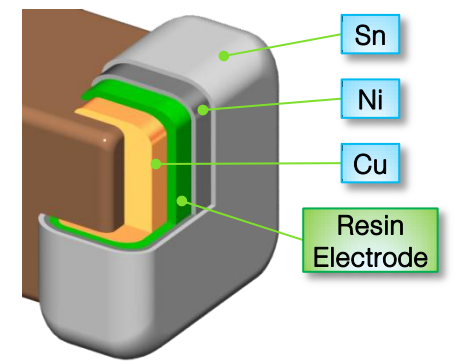

➤ Soft termination is available for 2in1 Array capacitor. A resin electrode layer between the copper base and the nickel plating of the terminal electrode absorbs bending stress from the board and suppresses the forming of solder cracks.

Ordering Information

COMMERCIAL & AUTOMOTIVE GRADE

CKC	L22	X5R	OJ	225	M	085	A	K
Series Name	Case Size	Temperature Characteristics	Voltage Code	Cap Code	Cap Tolerance	Thickness	Packaging Code	Special Code
CKC	N27 (2in1) M25 (2in1) L22 (2in1) L44 (4in1) A43 (4in1)	C0G (0±30ppm/°C) CH (0±60ppm/°C) JB (±10%) X5R (±15%) X7R (±15%) X8R (±15%)	OJ = 6.3V 1A = 10V 1C = 16V 1E = 25V 1H = 50V 2A = 100V	100 to 105	F = ±1% K = ±10% M = ±20%	045 = 0.45mm 060 = 0.60mm 080 = 0.80mm 085 = 0.85mm 100 = 1.00mm	A = 7" Reel/ 4mm Pitch B = 7" Reel/ 2mm Pitch	A = Internal B = Internal C = Internal K = (STD)Soft Termination L = (Auto)Soft Termination

LOW PROFILE MULTILAYER CERAMIC CAPACITOR



Series Overview

TDK's CGB Series is a low profile family of MLCCs best suited for height restricted applications such as mobile phones, MP3 players, flash memory cards, RFID packages and embedded devices. Common applications include its use as a filtering and/or decoupling capacitor in limited clearance configurations, including BGA (Ball Grid Array) packages. As demand for embedded applications increase, copper termination will be made available. Low profile MLCCs are available in 4 case sizes as 0201, 0402, 0603 and 0805, with a capacitance range of 0.22uF to 10uF and component thicknesses as low as 0.11mm max (under development).

Typical Layout with Standard SMT MLCC

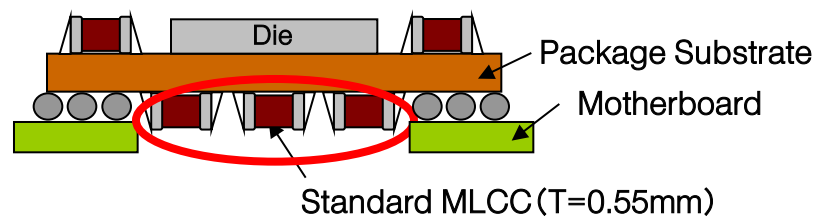

Standard height SMT cannot fit under package substrate.

New Layout with Low Profile SMT

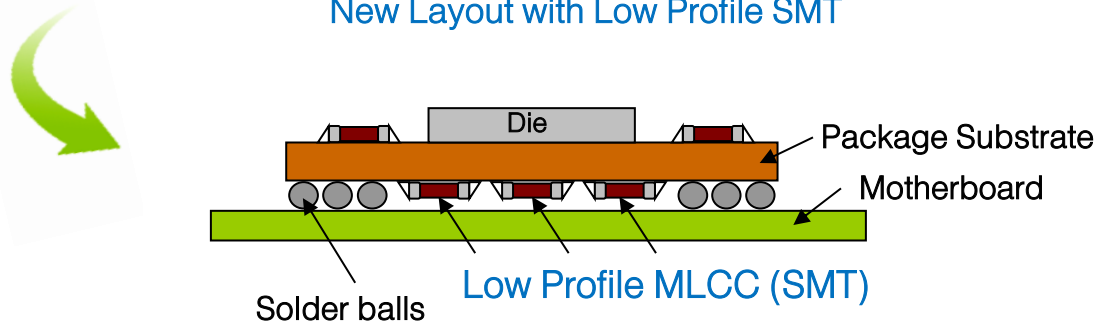

By using low profile MLCC, it is possible to mount MLCC between BGA and motherboard and save space on PCB.

Applications

- COMMERCIAL GRADE
- AUTOMOTIVE GRADE
- HIGH RELIABILITY

Design Advantage

- ❖ Maximum thickness available:
 - ✓ 0.22mm
 - ✓ 0.33mm
 - ✓ 0.55mm
 - ✓ 0.65mm
- ❖ Embedded use is available
- ❖ Available in 0201, 0402, 0603, and 0805
- ❖ Rated voltages: 4 to 25V
- ❖ Temperature range -55°C to +125°C
- ❖ T/CS: X5R, X6S, X7R, X7S

Design Questions

- ❖ Does your design have height restriction?
- ❖ Are you mounting caps under ASICs?
- ❖ Do you design:
 - ✓ Ball Grid Arrays?
 - ✓ SIM cards
 - ✓ Memory modules
 - ✓ Smart cards

Characteristics

Case Size	Voltage	Cap Range
CGB1 / 0201	4 - 6.3V	100nF
CGB2 / 0402	4 - 25V	220nF - 2.2uF
CGB3 / 0603	4 - 25V	470pF - 10uF
CGB4 / 0805	6.3 - 25V	680nF - 2.2uF

Ordering Information

COMMERCIAL GRADE

CGB	3	C	1	X5R	OJ	106	M	065	A	C
Series Name	Case Size	Thickness Code	Life Test Condition	Temperature Characteristics	Voltage Code	Cap Code	Cap Tolerance	Thickness	Packaging Code	Special Code
CGB	1 = C0603 2 = C1005 3 = C1608 4 = C2012	T = 0.22mm A = 0.33mm B = 0.55mm C = 0.65mm	1 = 1xRV 3 = 1.5xRV	JB (±10%) X5R (±15%) X6S (±22%) X7R (±15%) X7S (±22%)	0G = 4V 0J = 6.3V 1A = 10V 1C = 16V 1E = 25V	104 to 106	K = ±10% M = ±20%	022 = 0.22mm 033 = 0.33mm 055 = 0.55mm 065 = 0.65mm	A = 7" Reel/ 4mm Pitch B = 7" Reel/ 2mm Pitch	B = Internal C = Internal

REVERSED GEOMETRY MULTILAYER CERAMIC CAPACITOR



Series Overview

TDK low ESL reversed geometry capacitors offers industry standard case sizes in “flip” geometry construction. By rotating the orientation of the capacitor 90°, the current path through the unit is shortened and effectively lowers the parasitic inductance value. The flip geometry requires the termination to be applied along the length instead of the width of the MLCC. Reduced ESL is necessary for noise decoupling in high speed applications.

Design Construction of Flip Type Capacitor

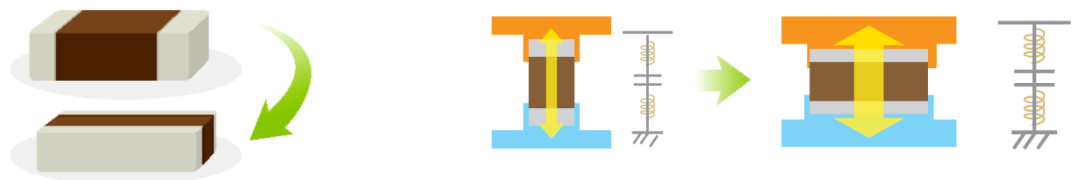

➤ For Flip Type Capacitor, ESL is lowered by reversing the terminal electrode length and width to make the current path short and wide.

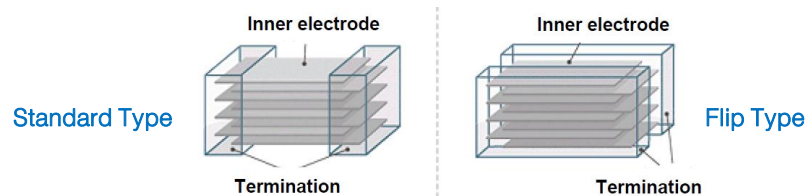

For decoupling capacitors, the parasitic inductance generated by the capacitor needs to be small so that the resonant frequency is higher. The parasitic inductance will add noise voltage spikes to the power line voltage as shown in the following equation:

$$V = L * \frac{\delta i}{\delta t}$$

$\delta i / \delta t$ can be very large when operating under very high frequency, where L is the parasitic inductance. In order to stabilize the power line without adding anymore noise from the capacitor, parasitic inductance needs to be small. Because of the unique design of the Flip Type capacitor, the parasitic inductance is lower than the traditional multilayer ceramic capacitor (MLCC). Therefore, the Flip Type MLCC is very effective for high speed decoupling applications.

Applications

- COMMERCIAL GRADE
- AUTOMOTIVE GRADE
- HIGH RELIABILITY

Design Advantage

- ❖ Reverse geometry lowers ESL (< 400pH)
- ❖ Passes adequate high freq current to IC
- ❖ Suppresses high-frequency noise
- ❖ Termination is applied to capacitor sides
- ❖ Temperature range -55°C to +125°C
- ❖ Rated voltage 4V to 50V
- ❖ T/Cs: X5R, X6S, X7R, X7S

Design Questions

- ❖ Do you need high-speed decoupling?
- ❖ Are you designing network systems?
- ❖ Do you need CPU/GPU power decoupling?

Characteristics

Case Size	Voltage	Cap Range
C0510 / 0204	2.5 - 16V	100nF - 1uF
C0816 / 0306	4 - 16V	10nF - 4.7uF
C1220 / 0508	6.3 - 50V	10nF - 1uF
C1632 / 0612	4 - 50V	10nF - 10uF

ESL Comparison

Capacitor Type	ESL (pH)
C1005 / 0402	STD 300
C0510 / 0204	FLIP 100
C1608 / 0603	STD 400
C0816 / 0306	FLIP 120
C2012 / 0805	STD 500
C1220 / 0508	FLIP 160
C3216 / 1206	STD 600
C1632 / 0612	FLIP 180

- ESR differs by capacitance
- ESR value of Flip Type is about 20~30% less than equivalent non-flip

Ordering Information

COMMERCIAL GRADE

C	1632	X5R	OJ	106	M	130	A	C
Series Name	Case Size	Temperature Characteristics	Voltage Code	Cap Code	Cap Tolerance	Thickness	Packaging Code	Special Code
C	0510 0816 1220 1632	JB (±10%) X5R (±15%) X6S (±22%) X7R (±15%) X7S (±22%)	0G = 4V 0J = 6.3V 1A = 10V 1C = 16V 1E = 25V 1H = 50V	103 to 106	M = ±20%	030 = 0.30mm 050 = 0.50mm 070 = 0.70mm 085 = 0.85mm 115 = 1.15mm 130 = 1.30mm	A = 7" Reel/ 4mm Pitch	C = Internal

ULTRA LOW INDUCTANCE MULTILAYER CERAMIC CAPACITOR

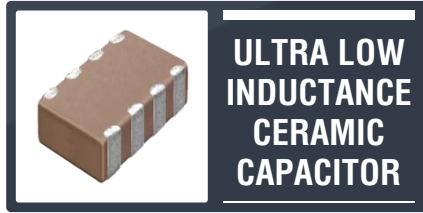

Series Overview

TDK's CLL multilayer ceramic capacitor series features ultra low inductance (less than 150 pH) and unique internal design. Ultra Low inductance are achieved with unique 8-terminal design. These terminals are connected in an alternating configuration which results in the cancelation of mutual inductance by alternating the flow of current so that the magnetic fields cancel each other out allowing for ultra low inductance along with reduced parasitic losses.

CLL Ultra Low Inductance series are available in two case sizes with operating temperature range of -55°C to +125°C and capacitance of up to 4.7µF. With voltage rating of 4V to 10V DC, CLL series are suitable for high speed IC decoupling as well as CPU power line decoupling. These capacitors are also effective for input/output smoothing in DC to DC converter.

Applications

- COMMERCIAL GRADE
- AUTOMOTIVE GRADE
- HIGH RELIABILITY

Design Advantage

- ❖ Unique electrode design
- ❖ Reduced inductance (< 150pH)
- ❖ Reduced parasitic loss
- ❖ Compact & light weight
- ❖ Supports lead-free soldering
- ❖ Temperature range -55°C to +125°C
- ❖ Rated voltage 4V to 10V
- ❖ T/Cs: X6S, X7R, X7S

Design Questions

- ❖ Do you have high impedance/current?
- ❖ Do you need high-speed decoupling?
- ❖ Do you need to reduce space and ESL?
- ❖ Do you need I/O smoothing?

Characteristics

Case Size	Voltage	Cap Range
CLLC1A	4V	47nF - 4.7uF
CLLE1A	4 - 10V	47nF - 6.8uF
CLLG1A	6.3 - 10V	1uF - 2.2uF

Attenuation vs Freq

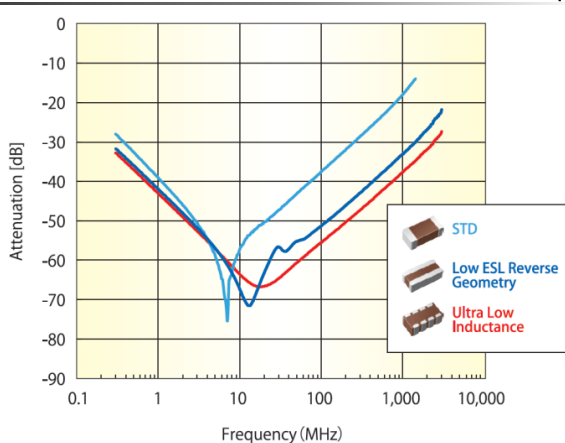

Unique Design of ULI Capacitor

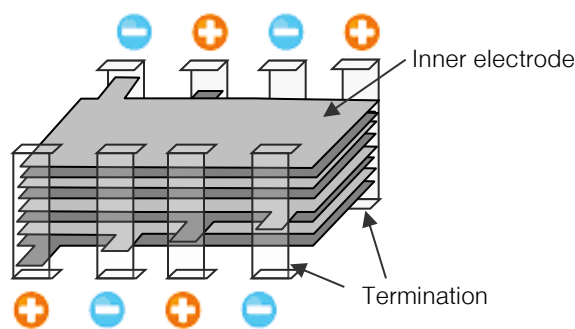

Equivalent Circuit

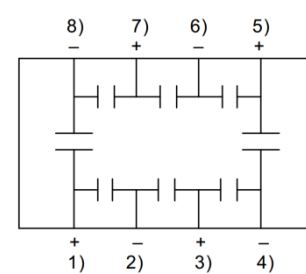

- + 1) 3) 5) 7)
- 2) 4) 6) 8)
- 8 terminals are connected and measured at the same time.

➤ Ultra-low ESL is created by alternating the flow of current so the magnetic fields cancel out.

Capacitance Range vs. ESL for different types of MLCCs

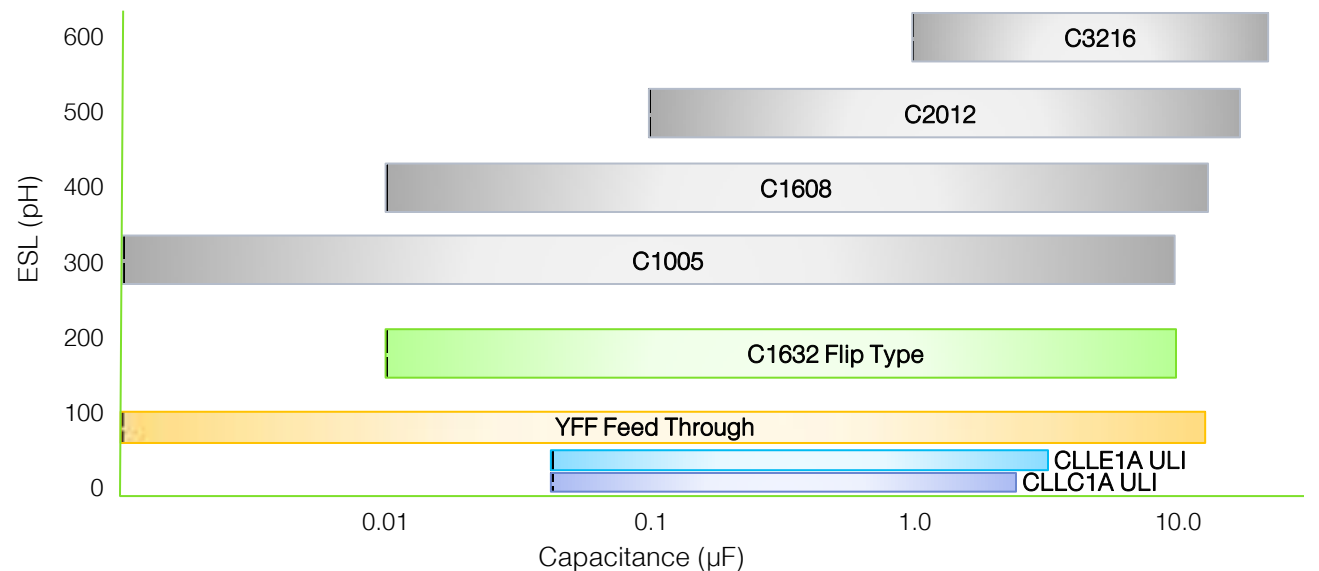

Ordering Information

COMMERCIAL GRADE

CLL	E1A	X7S	0G	685	M	050	A	C
Series Name	Case Size	Temperature Characteristics	Voltage Code	Cap Code	Cap Tolerance	Thickness	Packaging Code	Special Code
CLL	C1A = 0603 E1A = 0805 G1A = 1206	X6S (±22%) X7R (±15%) X7S (±22%)	0G = 4V 0J = 6.3V 1A = 10V	473 to 685	M = ±20%	050 = 0.50mm 055 = 0.55mm 085 = 0.85mm	A = 7" Reel/ 4mm Pitch	C = Internal

CONDUCTIVE EPOXY MULTILAYER CERAMIC CAPACITOR



Series Overview

TDK's Conductive Epoxy Series is a conductive glue-mounted device rather than solder-mounted. In high-temperature environments, the connectivity reliability is focused on the solder fillet because there are thermal expansion coefficient differences between the substrate, MLCC, and solder fillet. A conductive glue-mounted device allows for more "flexibility" during periods of expansion and contraction because the thermal expansion differences have been reduced by using a non-solder attachment.

Conductive glue is a common method of mounting components in applications that demand reliability at high temperatures, particularly in automotive environments. It's also used in applications that cannot be subjected to the heat of the solder paste mounting process, such as LCD panels, organic EL and LED displays, and CCD devices, which are particularly sensitive to high temperatures.

Applications

- COMMERCIAL GRADE
 - AUTOMOTIVE GRADE
 - HIGH RELIABILITY
- LONG LIFE

Design Advantage

- ❖ AgPdCu termination for glue mounting
- ❖ Improved thermal/mechanical adhesion
- ❖ Resistant to thermal expansion/contraction
- ❖ Reduced risk of silver migration
- ❖ Temperature range -55°C to +150°C
- ❖ Rated voltage 6.3V to 100V
- ❖ CDF-AEC-Q200 compliant (automotive)
- ❖ T/Cs: X7R, X8R, C0G

Design Questions

- ❖ Do you use conductive glue for mounting?
- ❖ Do you need high temp performance?
- ❖ Do you need automotive grade?

Characteristics

Case Size	Voltage	Cap Range
CGA2 / 0402	16 - 50V	1pF - 100nF
CGA3 / 0603	16 - 100V	1pF - 1uF
CGA4 / 0805	16 - 100V	2.7nF - 10uF
CGA5 / 1206	16 - 100V	4.7nF - 10uF
CGA6 / 1210	16 - 100V	470nF - 10uF

Standard Termination

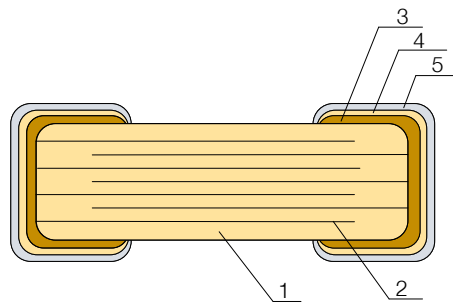

No.	NAME	MATERIAL	
		Class 1	Class 2
(1)	Ceramic Dielectric	CaZrO ₃	BaTiO ₃
(2)	Internal Electrode	Nickel (Ni)	
(3)		Copper (Cu)	
(4)	Termination	Nickel (Ni)	
(5)		Tin (Sn)	

AgPdCu Termination

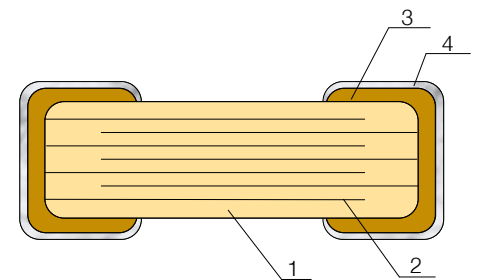

No.	NAME	MATERIAL	
		Class 1	Class 2
(1)	Ceramic Dielectric	CaZrO ₃	BaTiO ₃
(2)	Internal Electrode	Nickel (Ni)	
(3)		Copper (Cu)	
(4)	Termination	AgPdCu	

Ordering Information

AUTOMOTIVE GRADE

CGA	5	L	1	X7R	1E	106	K	160	A	D
Series Name	Case Size	Thickness Code	Life Test Condition	Temperature Characteristics	Voltage Code	Cap Code	Cap Tolerance	Thickness	Packaging Code	Special Code
CGA	2 = C1005 3 = C1608 4 = C2012 5 = C3216 6 = C3225	B = 0.50mm C = 0.60mm E = 0.80mm F = 0.85mm H = 1.15mm J = 1.25mm L = 1.60mm M = 2.00mm P = 2.50mm	1 = 1xRV 2 = 2xRV 3 = 1.5xRV	C0G (0±30ppm/°C) X7R (±15%) X8R (±15%)	0J = 6.3V 1C = 16V 1E = 25V 1V = 35V 1H = 50V 2A = 100V	010 to 106	C = ±0.25pF D = ±0.50pF J = ±5% K = ±10% M = ±20%	050 = 0.50mm 060 = 0.60mm 080 = 0.80mm 085 = 0.85mm 115 = 1.15mm 125 = 1.25mm 160 = 1.60mm 200 = 2.00mm 250 = 2.50mm	A = 7" Reel/ 4mm Pitch B = 7" Reel/ 2mm Pitch	D = Conductive Epoxy

SERIAL DESIGN MULTILAYER CERAMIC CAPACITOR



Series Overview

Automotive design often employs two distinct capacitors in a series on the PCB for power supply and battery line to protect the circuit from a short in case of cracking of the MLCC. In conjunction with our existing soft electrode technology, TDK offers 2 capacitors in single body construction in our CEU product line for ultra high reliability. Serial construction of inner electrode prevents sudden insulation breakdown after flex crack formation and soft termination technology allows for better absorption of external stress and protects the ceramic body. The combination of these technologies yield improved voltage and ESD performance over standard designs and decrease risk of short circuit failures and low IR due to mechanical flex cracks. Soft termination also allow for better performance with thermal expansion and contraction.

Applications

- COMMERCIAL GRADE
- AUTOMOTIVE GRADE
- HIGH RELIABILITY

Design Advantage

- ❖ Employs two distinct technologies
 - ✓ Floating electrode serial design
 - ✓ Conductive resin soft termination
- ❖ Short circuit protection from cracking
- ❖ Fail-open design
- ❖ Excellent thermal cycle performance
- ❖ Ultra-high reliability
- ❖ RoHS, WEE and REACH compliant
- ❖ CDF-AEC-Q200 compliant (automotive)
- ❖ T/C: X7R

Design Questions

- ❖ Do you have a battery direct circuit?
- ❖ Is short-circuit safety required?
- ❖ Do you have a high current circuit?
- ❖ Do you have excessive board flex?
- ❖ Are you designing a power bus circuit?
- ❖ Do you need automotive grade?

Characteristics

Case Size	Voltage	Cap Range
CEU3 / 0603	50 - 100V	1nF - 47nF
CEU4 / 0805	50 - 100V	1nF - 100nF

Ultra High Reliability Features!

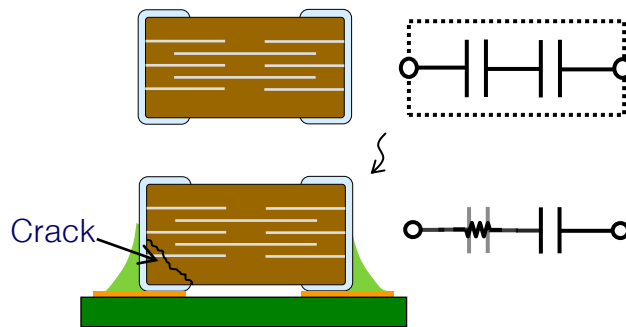

➤ Serial construction of inner electrode prevents sudden insulation breakdown after flex crack formation.

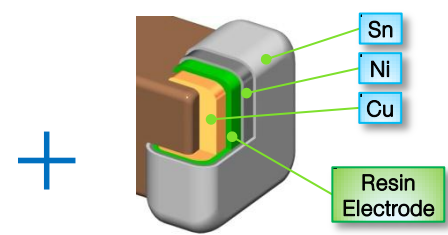

Soft Termination

➤ Conductive resin electrode layer absorbs external stress and protects ceramic body.

Ordering Information

AUTOMOTIVE GRADE

CEU	4	J	2	X7R	1H	104	K	125	A	E
Series Name	Case Size	Thickness Code	Life Test Condition	Temperature Characteristics	Voltage Code	Cap Code	Cap Tolerance	Thickness	Packaging Code	Special Code
CEU	3 = C1608 4 = C2012	E = 0.80mm J = 1.25mm	2 = 2xRV	X7R (±15%)	1H = 50V 2A = 100V	102 to 104	K = ±10% M = ±20%	080 = 0.80mm 115 = 1.15mm	B = 7" Reel/ 2mm Pitch	E = Soft Termination

ESD PROTECTION MULTILAYER CERAMIC CAPACITOR



Applications

- COMMERCIAL GRADE
- AUTOMOTIVE GRADE
- HIGH RELIABILITY

Design Advantage

- ❖ Compliant with the IEC 61000-4-2 standard for ESD immunity
- ❖ Available with COG and NP0 thermal characteristics
- ❖ Stable capacitance values regardless of DC bias, temperature or aging effects
- ❖ Qualified to AEC-Q200

Design Questions

- ❖ Are you working on automotive applications such as airbag controllers, remote keyless entry system, and navigation system?
- ❖ Do you need ESD protection for your input and output section of your circuit?
- ❖ Do you require 8KV (up to 30kV) of protection for your circuit?

Characteristics

Case Size	Voltage	Cap Range
CGA3 / 0603	100V	1nF - 10nF

ESD Ratings

Voltage	Capacitance	ESD Rating
100 V	1 nF	8 kV
	1.5 nF	10 kV
	2.2 nF	12 kV
	3.3 nF	16 kV
	4.7 nF	16 kV
	6.8 nF	22 kV
	10 nF	30 kV

Series Overview

TDK ESD Capacitor CGA3EA series are automotive grade MLCCs that meet the ESD immunity requirements according to the IEC 61000-4-2 standard. The new components are available in package size 1608 (EIA 0603) and offer rated capacitances ranging from 1 nF to 10 nF and a rated voltage of 100 V. The new series comprises two lineups of MLCCs with different thermal characteristics: COG components with a temperature range of -55°C to +125°C and a temperature coefficient of 0 ±30 ppm/°C max., and NP0 components with a temperature range of -55°C to +150°C and the same temperature coefficient.

The material used in the CGA3EA series features a low dielectric constant and thus maintains stable performance even when load conditions such as temperature or voltage change. The new components are therefore able to withstand ESD events of up to 8 kV and higher, as proven by the contact discharge test according to IEC 61000-4-2 (level 4). Mass production of the CGA3EA series, which is qualified to AEC-Q200, started in October 2013.

Development of the new MLCCs was made possible by TDK's know-how in a range of sophisticated technologies, including the pulverization of dielectric materials, high-dispersion processing, and both thin-layer and multilayer technology for dielectric ceramics. As a result the CGA3EA series are able to offer reliable ESD protection in a wide range of automotive electronics applications such as airbag controllers, remote keyless entry systems, navigation systems and more.

Ordering Information

AUTOMOTIVE GRADE

CGA	3	E	A	COG	2A	103	J	080	A	A
Series Name	Case Size	Thickness Code	Life Test Condition	Temperature Characteristics	Voltage Code	Cap Code	Cap Tolerance	Thickness	Packaging Code	Special Code
CGA	3 = C1608	E = 0.80mm	A = ESD	COG (0±30ppm/°C) NP0 (0±30ppm/°C)	2A = 100V	102 to 103	J = ±5%	080 = 0.80mm	A = 7" Reel/ 4mm Pitch B = 7" Reel/ 2mm Pitch	A = Internal C = Internal

HIGH RELIABILITY MULTILAYER CERAMIC CAPACITOR

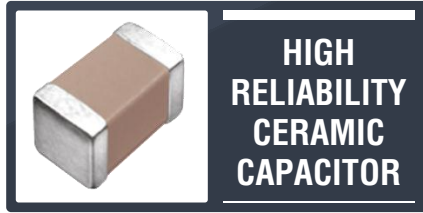

Series Overview

TDK's CGJ Series MLCC provides an extended life MLCC that meets electrical, mechanical, and environmental performance standards from multiple industry specifications. The enhanced reliability design allows it to be used in higher reliability applications in which maximum field life and the highest quality standards are required as well as for applications demanding performance levels beyond typical commercial grade and automotive grade performance.

In addition to our highest quality MLCC's, the customer will also receive a Sigma Report (Enhanced Certificate of Compliance) with each lot which includes electrical characterization data and estimated product life and anti-counterfeit packaging. Additionally, RFID (radio frequency identification) tags are available as an option. The Sigma Report and Product Authentication are available on-line at TDK.com.

Applications

- COMMERCIAL GRADE
- AUTOMOTIVE GRADE
- HIGH RELIABILITY

Design Advantage

- ❖ Extensive testing to ensure higher reliability and longer life
- ❖ Reliability tests based on select MIL-STD
- ❖ Guaranteed TC Bias
- ❖ Enhanced Certificate of Compliance
- ❖ UHF RFID tag for inventory management
- ❖ Tamper-proof seal for anti-counterfeit
- ❖ Priority support by factory (3/3/7)

Design Questions

- ❖ Do you need
 - ✓ reliable long-term performance?
 - ✓ anti-counterfeit assurance?
- ❖ Do you want to improve circuit uptime?
- ❖ Does your facility use RFID asset tracking?
- ❖ Is your equipment safety related?

Characteristics

Case Size	Voltage	Cap Range
CGJ2 / 0402	16 - 50V	1pF - 100nF
CGJ3 / 0603	6.3 - 200V	1pF - 2.2uF
CGJ4 / 0805	6.3 - 200V	100pF - 10uF
CGJ5 / 1206	6.3 - 500V	3.9nF - 10uF
CGJ6 / 1210	100 - 500V	47nF - 10uF

CGJ SERIES

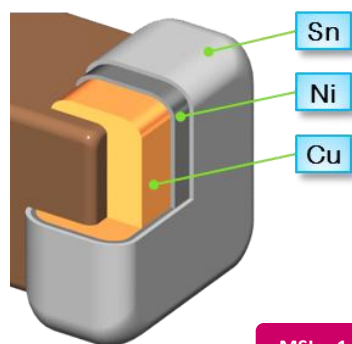

- High Reliability Grade Capacitor
- Anti-Counterfeit Features
- Sigma Report (Enhanced CoC)
- Passive RFID Tracking Label
- Premium Engineering Support

Ordering Information

HIGH RELIABILITY GRADE

CGJ	5	L	2	X7R	1A	106	K	160	A	A
Series Name	Case Size	Thickness Code	Life Test Condition	Temperature Characteristics	Voltage Code	Cap Code	Cap Tolerance	Thickness	Packaging Code	Special Code
CGJ	2 = C1005 3 = C1608 4 = C2012 5 = C3216 6 = C3225	B = 0.50mm C = 0.60mm E = 0.80mm F = 0.85mm H = 1.15mm J = 1.25mm K = 1.30mm L = 1.60mm M = 2.00mm	1 = 1xRV 2 = 2xRV 3 = 1.5xRV 4 = 1.2xRV	COG (0±30ppm/°C) X7R (±15%) X7S (±22%) X7T (+22/-33%)	0J = 6.3V 1C = 16V 1E = 25V 1H = 50V 2A = 100V 2D = 200V 2H = 500V	101 to 106	C = ± 0.25pF D = ± 0.50pF J = ±5% K = ±10%	050 = 0.50mm 060 = 0.60mm 080 = 0.80mm 085 = 0.85mm 115 = 1.15mm 125 = 1.25mm 130 = 1.30mm 160 = 1.60mm 200 = 2.00mm	A = 7" Reel/ 4mm Pitch B = 7" Reel/ 2mm Pitch	A = Internal

RADIAL LEAD TYPE MULTILAYER CERAMIC CAPACITOR



Series Overview

TDK offers the FK Series mid-voltage Dipped Radial Ceramic Capacitors that provide large electrostatic capacity while maintaining a high level of reliability. FK Series are multilayer ceramic capacitors attached with solder coated wire leads and dipped with UL94V-0 approved resin and formed with a "kink" to achieve consistent insertion heights and facilitate the release of gases during soldering for dramatically improved solderability. These capacitors support traditional functions such as decoupling, filtering, bypassing, and smoothing in general circuit applications. The FK series' residual inductance is small and provides good frequency characteristics. A most recent use of these leaded capacitors has been to combat acoustic noise in lighting applications. The FK Series is available in 2.5mm and 5.0mm lead spacing, 6.3V-630V, up to 100uF, and in X5R, X7R, X7S, COG temperature characteristics.

Applications

- COMMERCIAL GRADE
- AUTOMOTIVE GRADE
- HIGH RELIABILITY

Design Advantage

- ❖ No Polarity
- ❖ Provides large electrostatic capacity
- ❖ High level of reliability under specified environmental conditions
- ❖ Its residual inductance is small and it provides good frequency characteristics
- ❖ The leads are formed with a "kink" to achieve consistent insertion heights and facilitate the release of gases during soldering for dramatically improved solderability
- ❖ RoHS Compliant

Design Questions

- ❖ Do you have acoustic noise problem?
- ❖ Is your application high frequency?
- ❖ Do you need input protection?
- ❖ Do you require flame-retardant capacitors?

Characteristics

Case Size	Voltage	Cap Range
FK18	6.3 – 250V	1pF – 10uF
FK14	6.3 – 250V	820pF – 22uF
FK16	6.3 – 100V	3.9nF – 47uF
FK11	6.3 – 100V	15nF – 100uF
FK28	6.3 – 250V	1pF – 10uF
FK24	6.3 – 250V	820pF – 22uF
FK26	6.3 – 630V	100pF – 47uF
FK20	6.3 – 630V	3.9nF – 100uF
FK22	6.3 – 630V	8.2nF – 100uF

Temperature Characteristics

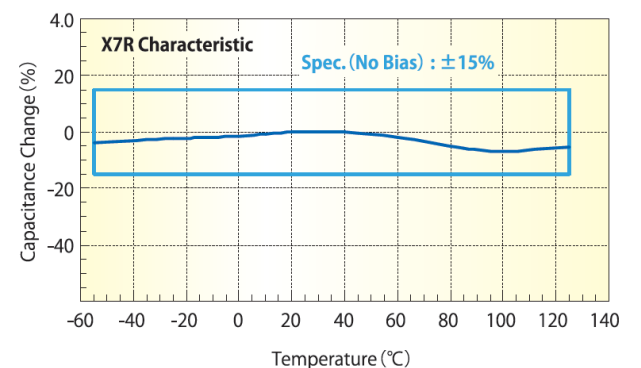
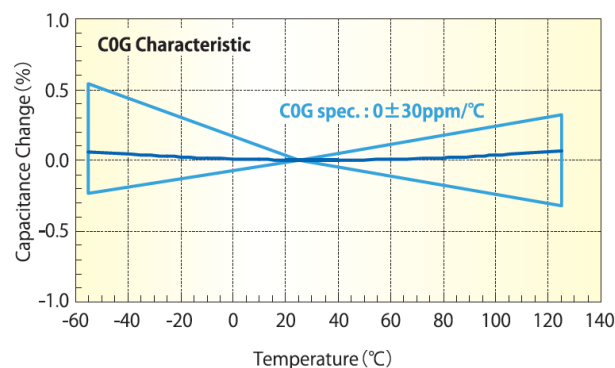

Impedance vs. Frequency Characteristics

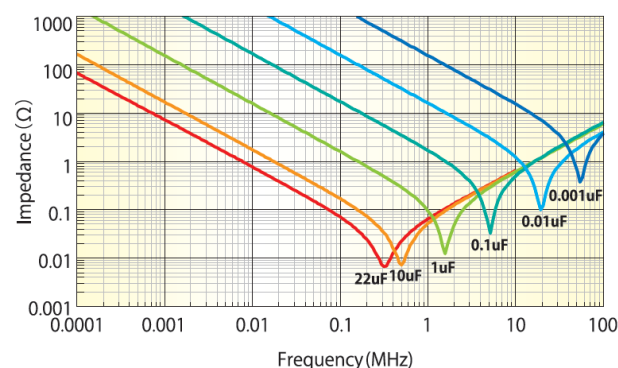

DC Bias Characteristics

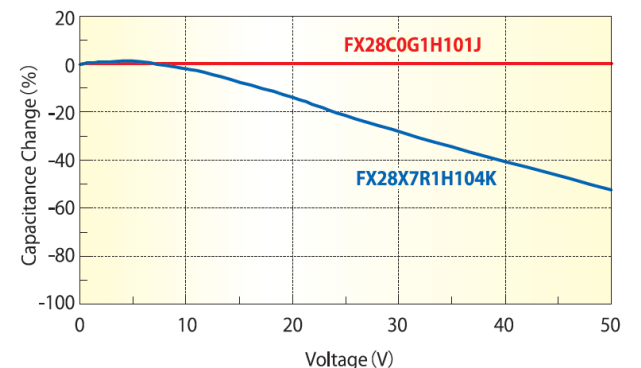

Ordering Information

COMMERCIAL GRADE

FK	28	COG	1H	101	J	□□□□
Series Name	Case Size	Temperature Characteristics	Voltage Code	Cap Code	Cap Tolerance	Internal Code
FK	28	COG (0±30ppm/°C)	0J = 6.3V	100	C = ± 0.25pF	
	24	X5R (±15%)	1A = 10V	to	D = ± 0.50pF	
	26	X7R (±15%)	1C = 16V	107	J = ±5%	
	20	X7S (±22%)	1E = 25V		K = ±10%	
	22		1H = 50V		M = ±20%	
	18		2A = 100V			
	14		2E = 250V			
	16		2J = 630V			
	11					

LEADED DISC TYPE HIGH VOLTAGE CERAMIC CAPACITOR



Series Overview

TDK's CD/CS Safety Disc Capacitors are ideal for AC Line to Line and Line to Ground Filtering, meeting safety standards of 11 different countries. This CD/CS Series are ceramic Disc capacitors with high dielectric strength, available in a Halogen Free Coating, and features taping packaging style for automatic insertion. TDK's Safety Disc Capacitors are capable of 125°C operating temperature in its Halogen Free version and offers 7.5 to 10mm lead spacing with a capacitance range up to 10nF.

TDK's CK/CC Series are Disc type ceramic capacitors with solder coated wire leads and adopts a UL94V-0 approved resin coating. These capacitors support traditional functions such as decoupling, and bypassing in general circuit applications. The CK/CC series is capable of 105°C operating temperature in its Halogen Free version and offers 5, 7.5, and 10mm lead spacing, with 1,000-3,000V voltage ratings and a capacitance range up to 10nF.

Applications

- COMMERCIAL GRADE
- AUTOMOTIVE GRADE
- HIGH RELIABILITY

Design Advantage

- ❖ High voltage ceramic capacitors series with higher reliability has been achieved through the use of TDK's original copper electrode material which allows for matching of the dielectric and ceramic dielectrics material to provide low dissipation factor
- ❖ These products shall conform to RoHS Directive due to lead(Pb) free of lead wire and internal solder material
- ❖ This product is compatible with halogen-free external resin coating (TDK recommends halogen-free products as standard)
- ❖ Flame-resistant reinforced outer insulation prevents fires, electrical shock, and other potential hazards
- ❖ The leads are formed with a "kink" to achieve consistent insertion heights and facilitate the release of gases during soldering for dramatically improved solderability
- ❖ X1/Y2 Insulation Sub Class for "Line to Ground" and "Across the Line" Applications

Construction

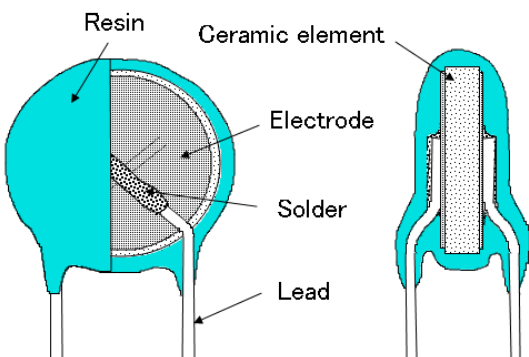

Impulse Withstanding Voltage Characteristics

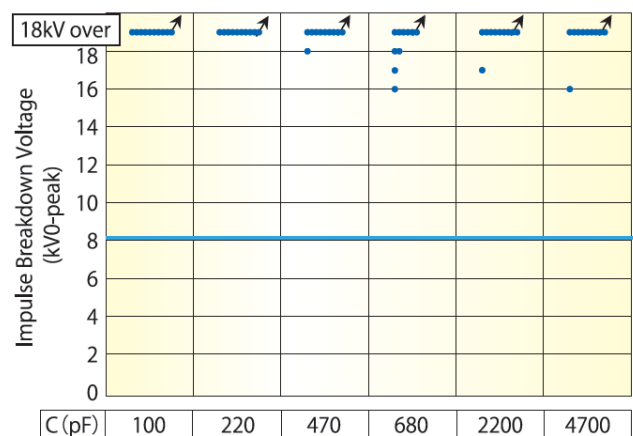

High impulse voltage characteristics based on International Standard IEC60384-14; Impulse test (8kV)

Withstanding Voltage Characteristics

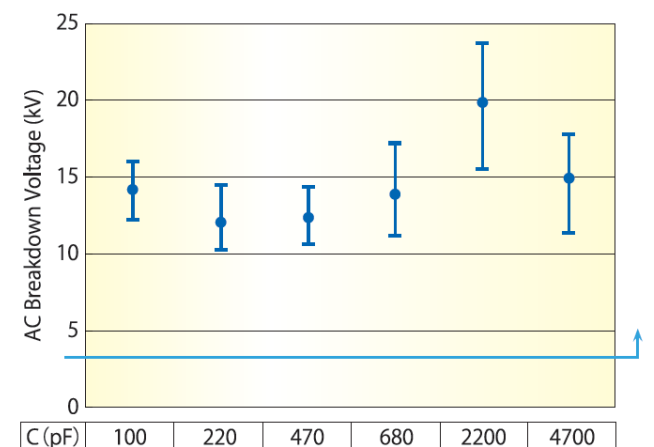

Withstanding Voltage: 4kVAC/60s, High breakdown voltage level

Ordering Information

COMMERCIAL & AUTOMOTIVE GRADE

CC	45	SL	3AD	101	J	Y	N	N	A
Series Name	Type / Diameter	Temperature Characteristics	Voltage Code	Cap Code	Cap Tolerance	JIS Grade	Lead Style	Application Code	Special Code
CC	45 = HV DISC	SL (+350 to -1000ppm/°C)	2GA = 400VAC	030	C = ± 0.25pF	A = Automotive	G = Vertical Kink Long	N = General Purpose	A = Halogen-Free
CK	70 = 7.0mm	Z5U (+22/-56%)	3AD = 1kVDC	to	D = ± 0.50pF	Y = Safety Class	N = Vertical Kink Short	S = Safety Application	
CD	75 = 7.5mm	-B (±10%)	3DD = 2KVDC	103	J = ±5%		N = Vertical Kink Short	R = Low Dissipation	
CS	85 = 8.5mm	-E (+20/-55%)	3FD = 3KVDC		K = ±10%		V = Vertical Kink Taping		
	90 = 9.0mm	-F (+30/-80%)	3JD = 6KVDC		M = ±20%				
	95 = 9.5mm	-R (+15/-30%)			Z = +80/-20%				
	10 = 10.5mm								
	11 = 11.5mm								
	12 = 11.5mm								
	13 = 12.5mm								
	14 = 13.5mm								
	15 = 14.5mm								
	16 = 15.5mm								
	17 = 16.5mm								

METAL FITTING TYPE ULTRA HIGH VOLTAGE CAPACITOR



Applications

- COMMERCIAL GRADE
- AUTOMOTIVE GRADE
- HIGH RELIABILITY

Design Advantage

- ❖ GA/H/TSF Series:
 - ✓ Strong in the impulse voltage
 - ✓ Low dissipation factor
 - ✓ Excellent voltage-capacitance characteristics
- ❖ FD/MD Series:
 - ✓ Compact size, exhibiting excellent low-loss, low distortion characteristics
 - ✓ Capacitance values largely unaffected by variations in applied voltage
 - ✓ Internal screw thread design simplifies mounting requirements
- ❖ UHV/FHV Series:
 - ✓ Low dissipation factor
 - ✓ Excellent voltage-capacitance characteristics

Specifications

Operating Temperature	-30°C to +85°C
Rated Voltage	DC: 20kV to 50kV AC: 10kVrms to 28kVrms
Insulation Resistance	100,000MΩ min.
Capacitance Range	50pF to 7,000pF
Capacitance Tolerance	±10%
Dissipation Factor (δ)	0.2% max.
Temperature Characteristics	C0G, Y5P, Y5S, Z5T
AC Corona Starting Voltage	3 pC max. at 50% of rated voltage min. (50Hz rms)
Withstanding Voltage	No breakdown at 1.5 times rated voltage for 60s (in oil)

Series Overview

TDK's UHV and FHV series high voltage ceramic capacitors feature low dissipation and excellent voltage-capacitance characteristics using patented strontium titanate (SrTiO₃) for dielectric material. They are epoxy-encapsulated to meet requirement of high voltage applications. The TSF, H, and GA Series are applicable to Gas Insulated Switchgear. TDK's FD/MD Series are molded from resins that provide outstanding insulation and moisture resistance, these capacitors are ideal for high-voltage power circuits in electrical power transmission and receiving devices.

Ordering Information

GA/H/TSF Series

Ordering Code	Rated Voltage	Capacitance (pF) ±10%	Withstand Voltage E _{rms} (kV)	Insulation resistance (MΩ) min.	Starting Corona Voltage E _{rms} (kV) AC min. (3pC)
GA-14	AC.10kV	1,700	20	100,000	10
H-11	AC.8kV	2,900	16	100,000	8
TSF-40C	AC.20kV	1,080	42	100,000	25
TSF-301	AC.20kV	400	42	100,000	25

FD/MD Series

Ordering Code	Rated Voltage	Capacitance (pF) ±10%	Withstand Voltage E _{rms} (kV)	Insulation resistance (MΩ) min.	Starting Corona Voltage E _{rms} (kV) AC min. (3pC)
FD-9AU	AC.10kVrms	100	15	100,000	12
FD-10AU		250	15	100,000	12
FD-11AU		500	15	100,000	12
FD-12AU		1,000	15	100,000	12
FD-16AU	AC.14kVrms	250	20	100,000	16
FD-18AU		500	20	100,000	16
FD-20AU	AC.20kVrms	1,000	20	100,000	16
FD-22AU		250	30	100,000	24
FD-24AU		500	30	100,000	24
FD-33AU		250	40	100,000	32
FD-36AU	AC.28kVrms	500	40	100,000	32
MD-1A	AC.20kVrms	50	30	100,000	15
MD-2A		53	30	100,000	15
MD-3A		100	30	100,000	15
MD-4A		150	30	100,000	15
MD-5A		AC.28kVrms	50	40	100,000

UHV/FHV Series

Ordering Code	Rated Voltage	Capacitance (pF) ±10%	Ordering Code	Rated Voltage	Capacitance (pF) ±10%	Ordering Code	Rated Voltage	Capacitance (pF) ±10%
UHV-221A	20kVDC	200	UHV-241A	40kVDC	100	FHV-1AN	20kVDC	1,700
UHV-222A		400	UHV-242A		200	FHV-2AN		3,000
UHV-223A		700	UHV-243A		400	FHV-3AN		5,200
UHV-224A		1,000	UHV-7A		700	FHV-4AN	1,200	
UHV-1A		1,400	UHV-8A		1,300	FHV-5AN	30kVDC	2,100
UHV-2A		2,500	UHV-9A		2,000	FHV-6AN	3,500	
UHV-3A	4,000	UHV-251A	100	FHV-7AN	40kVDC	850		
UHV-231A	200	UHV-252A	200	FHV-8AN		1,500		
UHV-232A	400	UHV-253A	400	FHV-9AN		2,600		
UHV-233A	30kVDC	700	UHV-10A	50kVDC	560	FHV-10AN	50kVDC	700
UHV-4A		940	UHV-11A		1,000	FHV-11AN		1,300
UHV-5A		1,700	UHV-12A		1,700	FHV-12AN	2,100	
UHV-6A		2,700	FHV-153AN		15kVDC	7,000		

What is E-Series?

- ❖ The E-Series is an EIA-5101 standard used by the industry to determine steps for capacitor and resistor values
- ❖ The E-Series is a geometric progression obtained by using a numeric base value

* TDK offers COG as E-12, X7R/X5R as E-6, and X7S/X6S as E-3.

Example:

- ❖ E-3 has 3 numbers and it's base value is $3\sqrt{10} = 2.2$
- ❖ The E-3 series capacitance steps are taken from the base values as follows: 2.2^0 , 2.2^1 , and 2.2^2
- ❖ Therefore, an E-3 series offering would include the following values: 100pF; 220pF; 470pF; 1,000pF; 2,200pF; 4,700, etc.

E-Series	Capacitance Steps											
E-1	1.0											
E-3	1.0				2.2				4.7			
E-6	1.0		1.5		2.2		3.3		4.7		6.8	
E-12	1.0	1.2	1.5	1.8	2.2	2.7	3.3	3.9	4.7	5.6	6.8	8.2

Cap Code	E-Series				pF	nF	μF
	1	3	6	12			
R12				✳	0.12	0.00012	0.00000012
R15			✳	✳	0.15	0.00015	0.00000015
R18				✳	0.18	0.00018	0.00000018
R22		✳	✳	✳	0.22	0.00022	0.00000022
R27				✳	0.27	0.00027	0.00000027
R33			✳	✳	0.33	0.00033	0.00000033
R39				✳	0.39	0.00039	0.00000039
R47		✳	✳	✳	0.47	0.00047	0.00000047
R56				✳	0.56	0.00056	0.00000056
R68			✳	✳	0.68	0.00068	0.00000068
R82				✳	0.82	0.00082	0.00000082
010	✳	✳	✳	✳	1	0.001	0.000001
1R2				✳	1.2	0.0012	0.0000012
1R5			✳	✳	1.5	0.0015	0.0000015
1R8				✳	1.8	0.0018	0.0000018
2R2		✳	✳	✳	2.2	0.0022	0.0000022
2R7				✳	2.7	0.0027	0.0000027
3R3			✳	✳	3.3	0.0033	0.0000033
3R9				✳	3.9	0.0039	0.0000039
4R7		✳	✳	✳	4.7	0.0047	0.0000047
5R6				✳	5.6	0.0056	0.0000056
6R8			✳	✳	6.8	0.0068	0.0000068
8R2				✳	8.2	0.0082	0.0000082
100	✳	✳	✳	✳	10	0.010	0.000010
120				✳	12	0.012	0.000012
150			✳	✳	15	0.015	0.000015
180				✳	18	0.018	0.000018
220		✳	✳	✳	22	0.022	0.000022
270				✳	27	0.027	0.000027
330			✳	✳	33	0.033	0.000033
390				✳	39	0.039	0.000039
470		✳	✳	✳	47	0.047	0.000047
560				✳	56	0.056	0.000056
680			✳	✳	68	0.068	0.000068
820				✳	82	0.082	0.000082
101	✳	✳	✳	✳	100	0.10	0.00010
121				✳	120	0.12	0.00012
151			✳	✳	150	0.15	0.00015
181				✳	180	0.18	0.00018
221		✳	✳	✳	220	0.22	0.00022
271				✳	270	0.27	0.00027
331			✳	✳	330	0.33	0.00033
391				✳	390	0.39	0.00039
471		✳	✳	✳	470	0.47	0.00047
561				✳	560	0.56	0.00056
681			✳	✳	680	0.68	0.00068
821				✳	820	0.82	0.00082
102	✳	✳	✳	✳	1,000	1	0.0010
122				✳	1,200	1.2	0.0012
152			✳	✳	1,500	1.5	0.0015
182				✳	1,800	1.8	0.0018
222		✳	✳	✳	2,200	2.2	0.0022
272				✳	2,700	2.7	0.0027
332			✳	✳	3,300	3.3	0.0033

Cap Code	E-Series				pF	nF	μF
	1	3	6	12			
392				✳	3,900	3.9	0.0039
472		✳	✳	✳	4,700	4.7	0.0047
562				✳	5,600	5.6	0.0056
682			✳	✳	6,800	6.8	0.0068
822				✳	8,200	8.2	0.0082
103	✳	✳	✳	✳	10,000	10	0.010
123				✳	12,000	12	0.012
153			✳	✳	15,000	15	0.015
183				✳	18,000	18	0.018
223		✳	✳	✳	22,000	22	0.022
273				✳	27,000	27	0.027
333			✳	✳	33,000	33	0.033
393				✳	39,000	39	0.039
473		✳	✳	✳	47,000	47	0.047
563				✳	56,000	56	0.056
683			✳	✳	68,000	68	0.068
823				✳	82,000	82	0.082
104	✳	✳	✳	✳	100,000	100	0.10
124				✳	120,000	120	0.12
154			✳	✳	150,000	150	0.15
184				✳	180,000	180	0.18
224		✳	✳	✳	220,000	220	0.22
274				✳	270,000	270	0.27
334			✳	✳	330,000	330	0.33
394				✳	390,000	390	0.39
474		✳	✳	✳	470,000	470	0.47
564				✳	560,000	560	0.56
684			✳	✳	680,000	680	0.68
824				✳	820,000	820	0.82
105	✳	✳	✳	✳	1,000,000	1,000	1
125				✳	1,200,000	1,200	1.2
155			✳	✳	1,500,000	1,500	1.5
185				✳	1,800,000	1,800	1.8
225		✳	✳	✳	2,200,000	2,200	2.2
275				✳	2,700,000	2,700	2.7
335			✳	✳	3,300,000	3,300	3.3
395				✳	3,900,000	3,900	3.9
475		✳	✳	✳	4,700,000	4,700	4.7
565				✳	5,600,000	5,600	5.6
685			✳	✳	6,800,000	6,800	6.8
825				✳	8,200,000	8,200	8.2
106	✳	✳	✳	✳	10,000,000	10,000	10
126				✳	12,000,000	12,000	12
156			✳	✳	15,000,000	15,000	15
186				✳	18,000,000	18,000	18
226		✳	✳	✳	22,000,000	22,000	22
276				✳	27,000,000	27,000	27
336			✳	✳	33,000,000	33,000	33
396				✳	39,000,000	39,000	39
476		✳	✳	✳	47,000,000	47,000	47
566				✳	56,000,000	56,000	56
686			✳	✳	68,000,000	68,000	68
826				✳	82,000,000	82,000	82
107	✳	✳	✳	✳	100,000,000	100,000	100